

Servomotors

NX Series

Technical Manual

PVD 3663

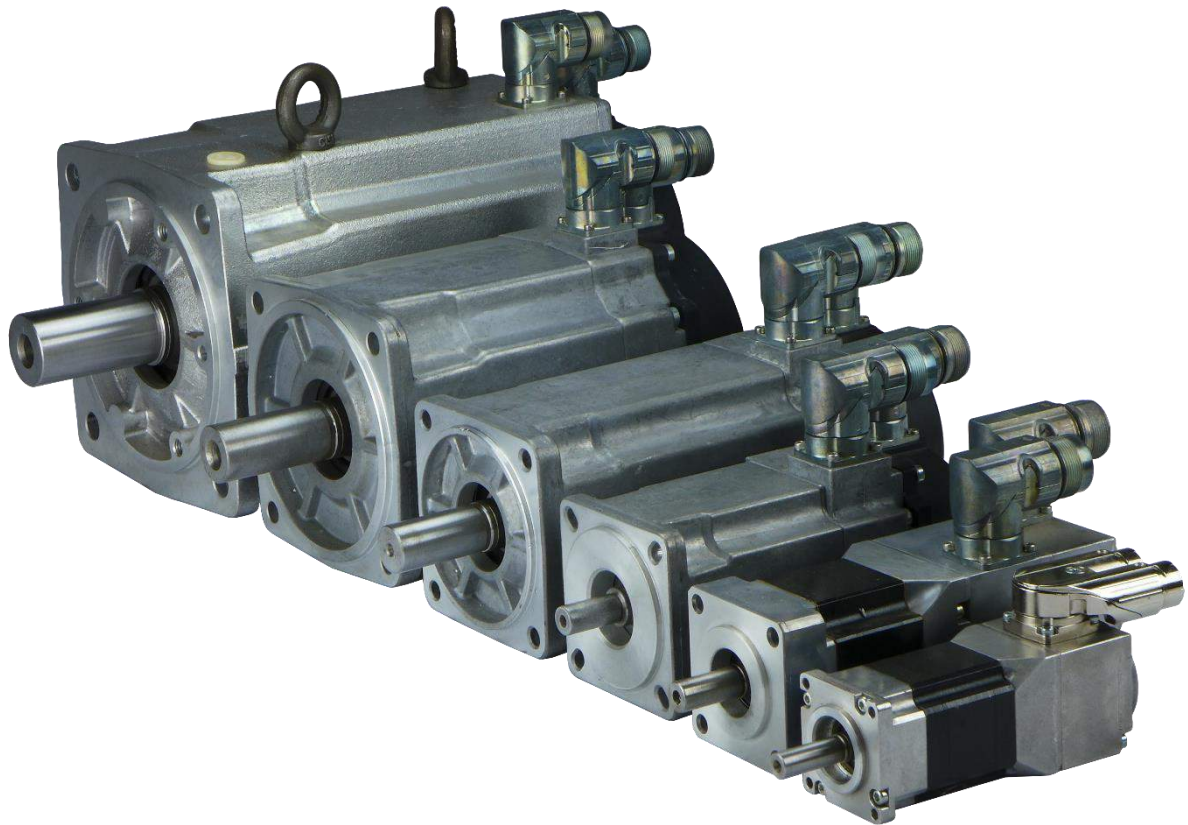



EU DECLARATION OF CONFORMITY

We ,

Parker Hannifin Manufacturing France SAS
Electromechanical & Drives Division Europe
Etablissement de Longvic
4 Boulevard Eiffel - CS40090
21604 LONGVIC Cedex - France

manufacturer, with brand name **Parker**, declare under our sole responsibility that the products

BRUSHLESS SERVOMOTORS TYPE NX1 / NX2 / NX3 / NX4 / NX6 / NX8

satisfy the arrangements of the directives :

Directive 2014/35/EU : “Low Voltage Directive”, LVD
Directive 2011/65/EU : “Restriction of Hazardous Substances”, RoHS
Directive 2014/30/EU : “Electromagnetic Compatibility”, EMC

and meet standards or normative document according to :

EN 60034-1:2010/AC:2010 : Rotating electrical machines - Part 1 : Rating and performance.
EN 60034-5:2001/A1:2007 : Rotating electrical machines - Part 5 : Degrees of protection provided by the integral design of rotating electrical machines (IP code) - Classification.
EN 60204-1:2006/AC:2010 : Safety of machinery – Electrical equipment of machines – Part 1 : General requirements.

The product itself is not impacted by the modifications made on the latest directives.

The undersigned certify that the above mentioned model is procured in accordance with the above directives and standards.

Further information :

SERVOMOTORS shall be mounted on a mechanical support providing good heat conduction and not exceeding 40° C in the vicinity of the motor flange.

The product must be installed in accordance with the instructions and recommendations contained in the operating instructions supplied with the product.

NX1 C.E. Marking : October 2004
NX2 C.E. Marking : November 2004
NX3 C.E. Marking : September 27th 2001

NX4 C.E. Marking : March 15th 2000
NX6 C.E. Marking : March 27th 2000
NX8 C.E. Marking : December 23th 2003

Longvic, May 17th 2016

In the name of Parker
A. ANDRIOT
Quality Manager

Ref : DCE-NX-001rev1

Compliance with «UL» standards

CERTIFICATE OF COMPLIANCE

Certificate Number 20151001-E242959
Report Reference E242959-20060112
Issue Date 2015-OCTOBER-01

Issued to: PARKER HANNIFIN MANUFACTURING FRANCE SAS
ESTABLISHMENT LONGVIC
4 Bd EIFFEL
21600 LONGVIC FRANCE

**This is to certify that
representative samples of**

COMPONENT - INCOMPLETE ROTATING MACHINES
AND ROTATING MACHINE PARTS
COMPONENT - SERVO AND STEPPER MOTORS
Brushless servo motor - Models NX 110, NX205, NX 210
followed by A; followed by A through Z, followed A through
Z, followed by R or B, followed by code 1,2,3,4,7 followed
by code 0 through 5 or A through F, followed by code 00
through 99

Have been investigated by UL in accordance with the
Standard(s) indicated on this Certificate.

Standard(s) for Safety: UL 1004-1, Rotating Electrical Machines - General
Requirements
C22.2 No. 100-04, Motors and Generators

Additional Information: See the UL Online Certifications Directory at
www.ul.com/database for additional information

Only those products bearing the UL Certification Mark should be considered as being covered by UL's
Certification and Follow-Up Service.

Recognized components are incomplete in certain constructional features or restricted in performance
capabilities and are intended for use as components of complete equipment submitted for investigation rather
than for direct separate installation in the field. The final acceptance of the component is dependent upon its
installation and use in complete equipment submitted to UL LLC.

Look for the UL Certification Mark on the product.



Bruce Maheshwari, Director North American Certification Program

UL LLC

Any information and documentation involving UL Mark certification is provided on behalf of UL LLC (UL) or any authorized licensee of UL. For questions, please
contact a local UL Customer Service Representative at ULCustomerService@ul.com



Compliance with «UL» standards

CERTIFICATE OF COMPLIANCE

Certificate Number 20151001-E242959
Report Reference E242959-20140618
Issue Date 2015-OCTOBER-01

Issued to: PARKER HANNIFIN MANUFACTURING FRANCE SAS
ESTABLISHMENT LONGVIC
4 Bid EIFFEL
21600 LONGVIC FRANCE

This is to certify that representative samples of COMPONENT - INCOMPLETE ROTATING MACHINES AND ROTATING MACHINE PARTS
COMPONENT - SERVO AND STEPPER MOTORS
See Addendum Page

Have been investigated by UL in accordance with the Standard(s) indicated on this Certificate.

Standard(s) for Safety: UL 1004-1, Rotating Electrical Machines - General Requirements
UL 1004-6, Servo and Stepper Motors
C22.2 No. 100-04, Motors and Generators

Additional Information: See the UL Online Certifications Directory at www.ul.com/database for additional information

Only those products bearing the UL Certification Mark should be considered as being covered by UL's Certification and Follow-Up Service.

Recognized components are incomplete in certain constructional features or restricted in performance capabilities and are intended for use as components of complete equipment submitted for investigation rather than for direct separate installation in the field. The final acceptance of the component is dependent upon its installation and use in complete equipment submitted to UL LLC.

Look for the UL Certification Mark on the product.



Bruce Maherholz, Director North America Certification Program

UL LLC

Any information and documentation including UL Mark shall not be provided on behalf of UL LLC (UL) or any authorized licensee of UL. For questions, please contact a local UL Customer Service Representative at ul@ul.com or ul.com/customer-service





Table of Content

1. INTRODUCTION	7
1.1. Purpose and intended audience	7
1.2. Safety	7
1.2.1. Principle	7
1.2.2. General Safety Rules	8
2. PRODUCT DESCRIPTION	9
2.1. Quick URL	9
2.2. Overview	9
2.3. Applications	9
2.4. General Technical Data	10
2.5. Product Code	11
3. TECHNICAL DATA	12
3.1. Motor selection	12
3.1.1. Altitude derating	12
3.1.2. Temperature derating	12
3.1.3. Thermal equivalent torque (rms torque)	14
3.1.4. Drive selection	16
3.1.5. Current limitation at stall conditions (i.e. speed < 3 rpm)	19
3.1.6. Peak current limitations	19
3.2. NX Characteristics: Torque, speed, current, power	20
3.2.1. NX datas – Mains voltage 230V	21
3.2.2. NX datas – Mains voltage 400V	22
3.2.3. Further Data	23
3.2.4. Efficiency curves	24
3.2.5. Electromagnetic losses	32
3.2.6. Time constants of the motor	33
3.2.7. Speed ripple	35
3.2.8. Cogging torque	35
3.2.9. Rated data according to rated voltage variation	36
3.2.10. Voltage withstand characteristics of NX series	38
3.3. Dimension drawings	39
3.3.1. NX1	39
3.3.2. NX1 UL version	42
3.3.3. NX2	46
3.3.4. NX2 UL version	50
3.3.5. NX3	54
3.3.6. NX4	57
3.3.7. NX6	61
3.3.8. NX8	64
3.3.9. NX8 water cooled	68
3.4. Motor Mounting	69
3.4.1. Motor mounting	69
3.4.2. Frame recommendation	70
3.5. Shaft Loads	71
3.5.1. Vibration resistance to shaft end	71
3.5.2. Motors life time for horizontal mounting	71
3.6. Cooling	77
3.6.1. Natural and fan cooled motor	77
3.6.2. Fan cooled motor	78
3.6.3. Water cooled motor	79
3.6.4. Additives for water as cooling media	80
3.6.5. Motor cooling circuit drop pressure	81
3.6.6. Chiller selection	81
3.6.7. Flow derating according to glycol concentration	82
3.6.8. Water cooling diagram	84
3.7. Thermal Protection	86
3.7.1. Alarm tripping with PTC thermistors	86



3.7.2.	Temperature measurement with KTY sensors:.....	87
3.8.	Power Electrical Connections	88
3.8.1.	Wires sizes	88
3.8.2.	Conversion Awg/kcmil/mm ² :.....	89
3.8.3.	Motor cable length.....	90
3.8.4.	Mains supply connection diagrams	91
3.9.	Feedback system	98
3.9.1.	Resolver 2 poles transformation ratio = 0.5 – code A.....	98
3.9.2.	Hiperface encoder singleturn EKS36 DSL SIL2 – code P	98
3.9.3.	Hiperface encoder multiturn EKM36 DSL SIL2 – code Q	99
3.9.4.	Hiperface encoder singleturn SKS36 (128pulses) – code R.....	99
3.9.5.	Hiperface encoder multiturn SKM36 (128pulses) – code S	100
3.9.6.	Hiperface encoder singleturn SRS50 (1024pulses) – code T	100
3.9.7.	Hiperface encoder multiturn SRM50 (1024pulses) – code U.....	101
3.9.8.	Endat encoder singleturn ECN1113 – code V	101
3.9.9.	Endat encoder multiturn ECN1125 – code W	102
3.9.10.	Incremental encoder-Commutated lines 10 poles–2048pulses–code X (On request)	104
3.9.11.	Cables.....	105
3.10.	Brake option	108
4.	COMMISSIONING, USE AND MAINTENANCE	109
4.1.	Instructions for commissioning, use and maintenance	109
4.1.1.	Equipment delivery	109
4.1.2.	Handling	109
4.1.3.	Storage	110
4.2.	Installation	110
4.2.1.	Mounting.....	110
4.2.2.	Preparation	111
4.2.3.	Mechanical installation	111
4.3.	Electrical connections	112
4.3.1.	Cable connection.....	113
4.3.2.	Encoder cable handling.....	113
4.4.	Maintenance Operations	114
4.4.1.	Summary maintenance operations.....	114
4.5.	Troubleshooting	115

1. INTRODUCTION

1.1. Purpose and intended audience

This manual contains information that must be observed to select, install, operate and maintain PARKER NX servomotors.

Installation, operation and maintenance of the equipment should be carried out by qualified personnel. A qualified person is someone who is technically competent and familiar with all safety information and established safety practices; with the installation process, operation and maintenance of this equipment; and with all the hazards involved.

Reading and understanding the information described in this document is mandatory before carrying out any operation on the motors. If any malfunction or technical problem occurs, that has not been dealt with in this manual, please contact PARKER for technical assistance. In case of missing information or doubts regarding the installation procedures, safety instructions or any other issue tackled in this manual, please contact PARKER as well.

PARKER's responsibility is limited to its servomotors and does not encompass the whole user's system. Data provided in this manual are for product description only and may not be guaranteed, unless expressly mentioned in a contract.

	<p><u>DANGER:</u> PARKER declines responsibility for any industrial accident or material damage that may arise, if the procedures and safety instructions described in this manual are not scrupulously followed.</p>
---	--





1.2. Safety

1.2.1. Principle

To operate safely, this equipment must be transported, stored, handled, installed and serviced correctly. Following the safety instructions described in each section of this document is mandatory. Servomotors usage must also comply with all applicable standards, national directives and factory instructions in force.

	<p><u>DANGER:</u> Non-compliance with safety instructions, legal and technical regulations in force may lead to physical injuries or death, as well as damages to the property and the environment.</p>
---	--

1.2.2. General Safety Rules

	<p>Generality DANGER: The installation, commission and operation must be performed by qualified personnel, in conjunction with this documentation.</p> <p>The qualified personnel must know the safety (C18510 authorization, standard VDE 0105 or IEC 0364) and local regulations.</p> <p>They must be authorized to install, commission and operate in accordance with established practices and standards.</p>
	<p>Electrical hazard</p> <p>Servo drives may contain non-insulated live AC or DC components. Respect the drives commissioning manual. Users are advised to guard against access to live parts before installing the equipment.</p> <p>Some parts of the motor or installation elements can be subjected to dangerous voltages, when the motor is driven by the inverter , when the motor rotor is manually rotated, when the motor is driven by its load, when the motor is at standstill or stopped.</p> <p>For measurements use only a meter to IEC 61010 (CAT III or higher). Always begin using the highest range. CAT I and CAT II meters must not be used on this product.</p> <p>Allow at least 5 minutes for the drive's capacitors to discharge to safe voltage levels (<50V). Use the specified meter capable of measuring up to 1000V dc & ac rms to confirm that less than 50V is present between all power terminals and between power terminals and earth.</p> <p>The motor must be permanently connected to an appropriate safety earth. The continuity of the grounding circuit has to be checked on the complete circuit : the resistance between any conductive point and the grounding conductor shall not exceed more than 100mΩ</p> <p>To prevent any accidental contact with live components, it is necessary to check that cables are not damaged, stripped or not in contact with a rotating part of the machine. The work place must be clean, dry.</p> <p>General recommendations :</p> <ul style="list-style-type: none"> - Check the wiring circuit - Lock the electrical cabinets - Use standardized equipment
	<p>Mechanical hazard</p> <p>Servomotors can accelerate in milliseconds. Running the motor can lead to other sections of the machine moving dangerously. Moving parts must be screened off to prevent operators coming into contact with them. The working procedure must allow the operator to keep well clear of the danger area.</p>
	<p>Burning Hazard</p> <p>Always bear in mind that some parts of the surface of the motor can reach temperatures exceeding 100°C.</p>



2. PRODUCT DESCRIPTION

2.1. Quick URL

All informations and datas are available on :

<http://www.parker.com/eme/nx>

2.2. Overview

NX servomotors Series from PARKER is an innovative direct drive solution designed for industrial applications. NX Series brushless servomotors from Parker SSD Parvex combine exceptional precision and motion quality, high dynamic performances and very compact dimensions.

A large set of torque / speed characteristics, options and customization possibilities are available, making NX Series servomotors the ideal solution for most servosystems applications.

Advantages

- High precision
- High motion quality
- High dynamic performances
- Compact dimensions and robustness
- Large set of options and customization possibilities
- CE and UL marking certification available.

2.3. Applications

Medical: Blood pumps, air pump, radiology tables,...

Machine tools: Ancillary axis, spindle, axis...

Semiconductor

Hand tool: screwdriver,...

Packaging machinery

Robot applications

Special machines

Pumps



2.4. General Technical Data

	NX1	NX2	NX3, NX4, NX6	NX8
Motor type	Permanent-magnet synchronous motor			
Magnets material	Neodymium Iron Boron			
Number of poles	10			
Type of construction	IMB5 – IMV1 – IMV3 (EN60034-7)			
Degree of protection	<ul style="list-style-type: none"> • IP64, • IP65 in option 		<ul style="list-style-type: none"> • IP64, • IP65 in option • IP44 in fan cooled version 	
Cooling	<ul style="list-style-type: none"> • Natural cooling 		<ul style="list-style-type: none"> • Natural cooling, • Fan cooled • Water cooled 	
Rated voltage	230VAC	230VAC, 400 VAC and 480 VAC		
Insulation of the stator winding	Class F according to IEC 60034-1 with potting	Class F according to IEC 60034-1	Class F according to IEC 60034-1 with potting	
Altitude	Up to 1000m (IEC 60034-1) (for higher altitude see §3.1.1 for derating)			
Ambiant temperature	<ul style="list-style-type: none"> • -15°C to +40°C (IEC 60034-1) • -40°C on request • 0°C to 40°C for water cooled version (IEC 60034-1) to avoid condensation see §3.5 			
Storage temperature	-20... +60°C			
Vibration severity	Grade A according to IEC 60034-14			
Shaft	Plain shaft as standard – key on shaft as an option			
Connection	<ul style="list-style-type: none"> • Connector, • Cable (Not UL) • Flying wires (Not UL) 		<ul style="list-style-type: none"> • Connectors • Terminal box 	
Marking	<ul style="list-style-type: none"> • CE, • UL in class A as an option 	<ul style="list-style-type: none"> • CE, • UL as an option 	<ul style="list-style-type: none"> • CE, • UL as an option 	
Paint finish	Raw as a standard, Black RAL 9005 as an option			
Sensor	Resolver transformation ratio = 0.5 as standard			
Hiperface - SKS36	N/A	Option	Option	
Hiperface - SKM36	N/A	Option	Option	
Hiperface DSL EKS36	N/A	N/A	Option	
Hiperface DSL EKM36	N/A	N/A	Option	
Hiperface – SRS50	N/A	N/A	Option	
Hiperface – SRM50	N/A	N/A	Option	
Endat ECN1113	N/A	N/A	Option	
Endat ECN1125	N/A	N/A	Option	
Incremental 2048line	N/A	On request	On request	
Sensorless	N/A	Option	Option	
Brake	Parking brake as an option			
Thermal protection	PTC, Thermoswitch or KTY as an option			
Remark	Numerous customization are possible on request (special shaft, connection, encoder, ...)			

3. TECHNICAL DATA

3.1. Motor selection

3.1.1. Altitude derating

From 0 to 1000 m : no derating

1000 to 4000 m: torque derating of 5% for each step of 1000 m for water cooled

1000 to 4000 m: torque derating of 10% for each step of 1000 m for air cooled

3.1.2. Temperature derating

3.1.2.1. Natural cooled motor

The maximal temperature for natural cooling is 40°C. But, it is possible to increase a little bit the ambient temperature above 40°C, with a torque reduction. The following formula gives an indicative about the torque derating at low speed. But in any case refer to PARKER technical department to know the exact values

At low speed the torque derating is given by the following formula for an ambient temperature > 40°C.

$$\text{Torque_derating}[\%] = 100 * \sqrt{\frac{(145^{\circ}\text{C} - \text{Ambient_temperature}^{\circ}\text{C})}{105^{\circ}\text{C}}}$$

	<p>At high speed, the calculation is more complex, and the derating is much more important. Please refer to PARKER to know the precise data of Torque derating according to ambient temperature at high speed for a specific motor.</p>
--	---

Illustration: Only for example given for the NX620EAR :

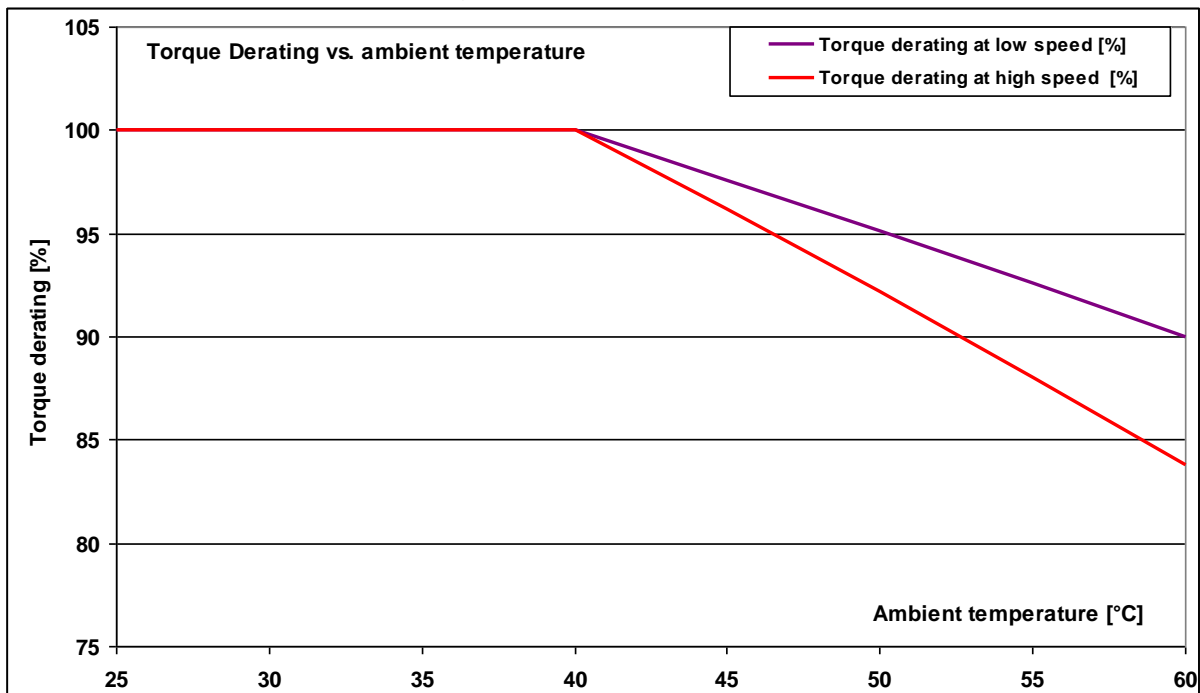

3.1.2.2. Water cooled motor

Typical values are given with a water inlet temperature of 25°C and a temperature gradient Inlet-Outlet of 10°C. These references lead to a winding overheating of 95°C corresponding to a winding temperature of 120°C. Recommendations regarding condensation issues are given at § 3.5

It is possible to increase a little bit the Inlet temperature up to 40°C, but the torque must be reduced. The following formula gives an indicative of the torque derating at low speed. But in any case refer to PARKER technical department to know the exact values

At low speed the torque derating is given by the following formula for an water Inlet temperature > 25°C.

$$Torque_derating[\%] = 100 * \sqrt{\frac{(120^{\circ}C - Inlet_temperature^{\circ}C)}{95^{\circ}C}}$$

	<p>At high speed, the calculation is more complex, and the derating is much more important. Please refer to PARKER to know the precise data of Torque derating according to water inlet temperature at high speed for a specific motor.</p>
---	---

Illustration: Only for example given for the NX860WAF



3.1.3. Thermal equivalent torque (rms torque)

The selection of the right motor can be made through the calculation of the rms torque M_{rms} (i.e. root mean squared torque) (sometimes called equivalent torque).

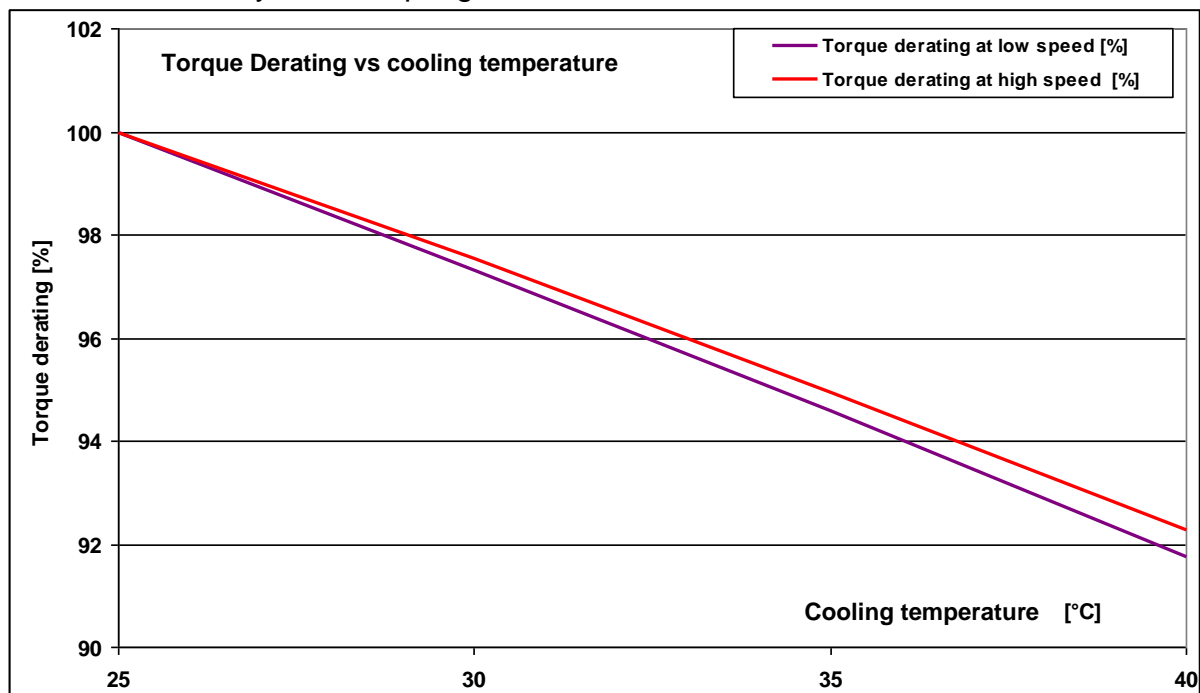
This calculation does not take into account the thermal time constant. It can be used only if the overload time is much shorter than the copper thermal time constant.

The rms torque M_{rms} reflects the heating of the motor during its duty cycle.

Let us consider:

- the period of the cycle T [s],

- the successively samples of movements i characterized each ones by the maximal torque M_i [Nm] reached during the duration Δt_i [s].

So, the rms torque M_{rms} can be calculated through the following basic formula:

$$M_{rms} = \sqrt{\frac{1}{T} * \sum_{i=1}^n M_i^2 \Delta t_i}$$

Example:

For a cycle of 2s at 0 Nm and 2s at 10Nm and a period of 4 s, the rms torque is

$$M_{rms} = \sqrt{\frac{1}{4} * 10^2 * 2} = 7,07 Nm$$

Illustration :

Acceleration-deceleration torque:	10 Nm for 0,1 s.
Resistant torque:	1 Nm during all the movement.
Max-min speed:	± 2800 rpm during 0,2 s.
Max torque provided by the motor:	11 Nm.
rms torque:	6 Nm.

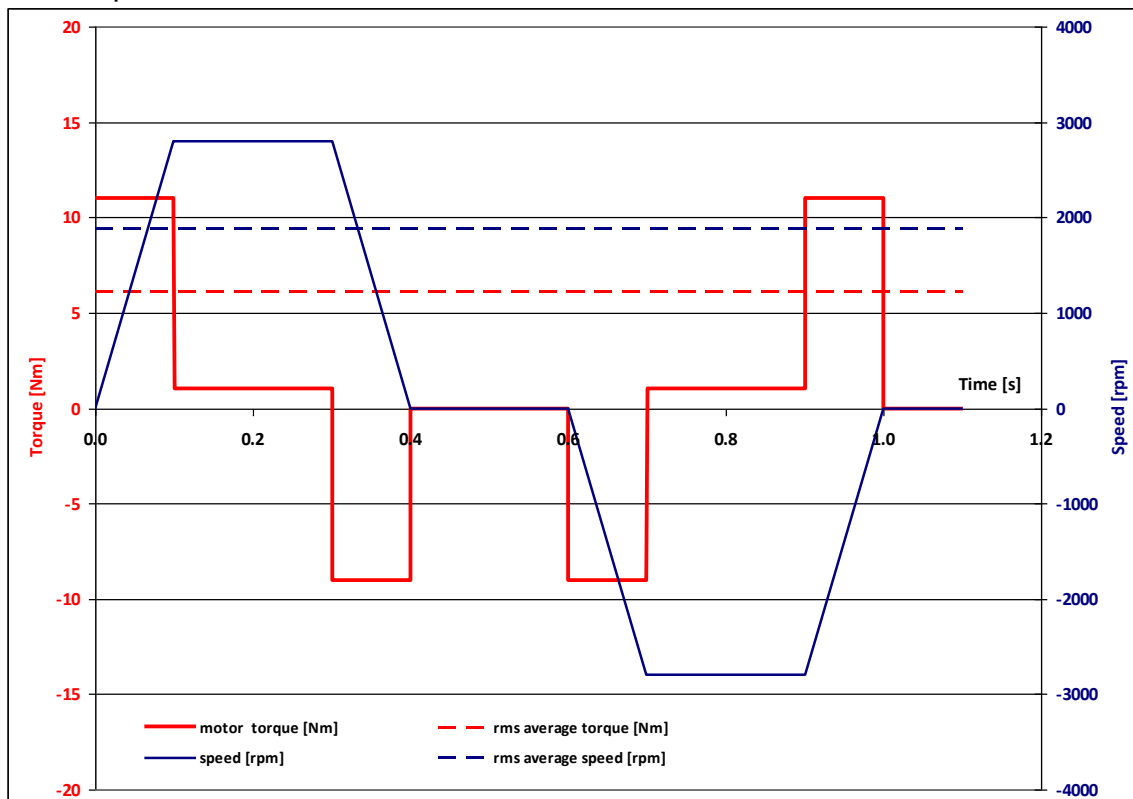

The maximal torque M_i delivered by the motor at each segment i of movement is obtained by the algebraic sum of the acceleration-deceleration torque and the resistant torque. Therefore, M_{max} corresponds to the maximal value of M_i .

Selection of the motor :

The motor adapted to the duty cycle has to provide the rms torque M_{rms} at the rms speed(*) without extra heating. This means that the permanent torque M_n available at the average speed presents a sufficient margin regarding the rms torque M_{rms} .

$$\Omega_{rms} = \sqrt{\frac{1}{T} * \sum_{i=1}^n \Omega_i^2 \Delta t_i}$$

(*) rms speed is calculated thanks to the same formula as that used for the rms torque. The mean speed cannot be used (in general mean speed is equal to zero). Only use the rms speed.

Furthermore, each M_i and speed associated Ω_i of the duty cycle has to be located in the operational area of the torque vs speed curve.

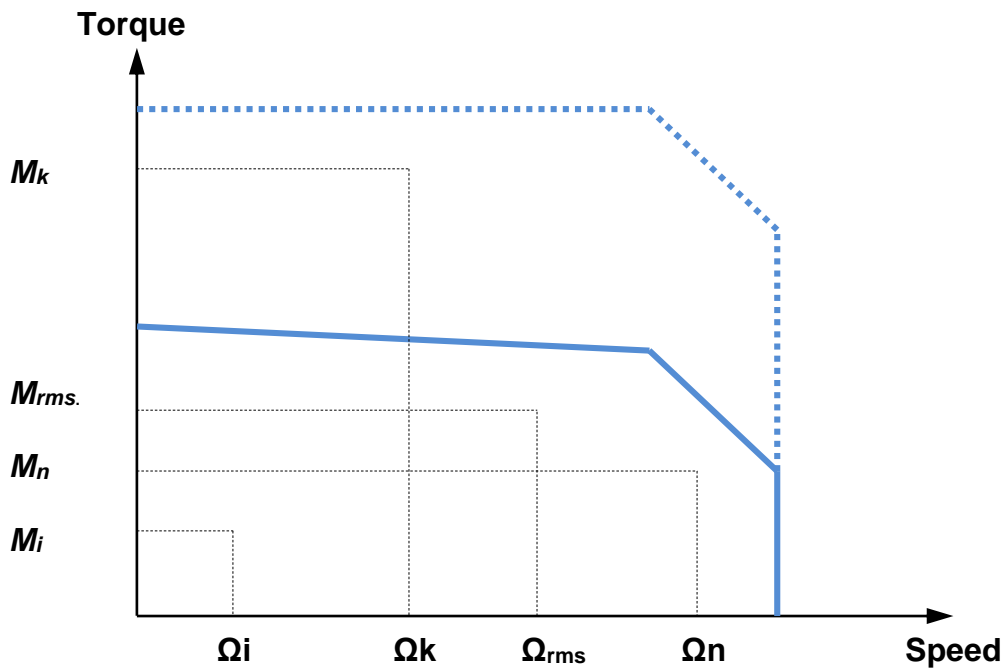

3.1.4. Drive selection

Drive selection depends on its rated power and its mode selection which leads to the maximal current duration.

	<p>Please refer to the drive technical documentation for any further information and to select the best motor and drive association.</p>
--	--

AC890 PARKER drive example:

The rated current provided by the AC890 drive depends on its rated power and its mode selection. “Vector mode” is used for induction motors while “Servo mode” is used for brushless AC motors. With NX motors the power is usually < 37 kW, the rated current corresponds to 100 %.

Power of Drive AC890 [kW]	< 37 kW	
Mode	Vector mode	Servo mode
Overload capability [%]	150 % during 60 s	200 % during 4 s

Illustration:

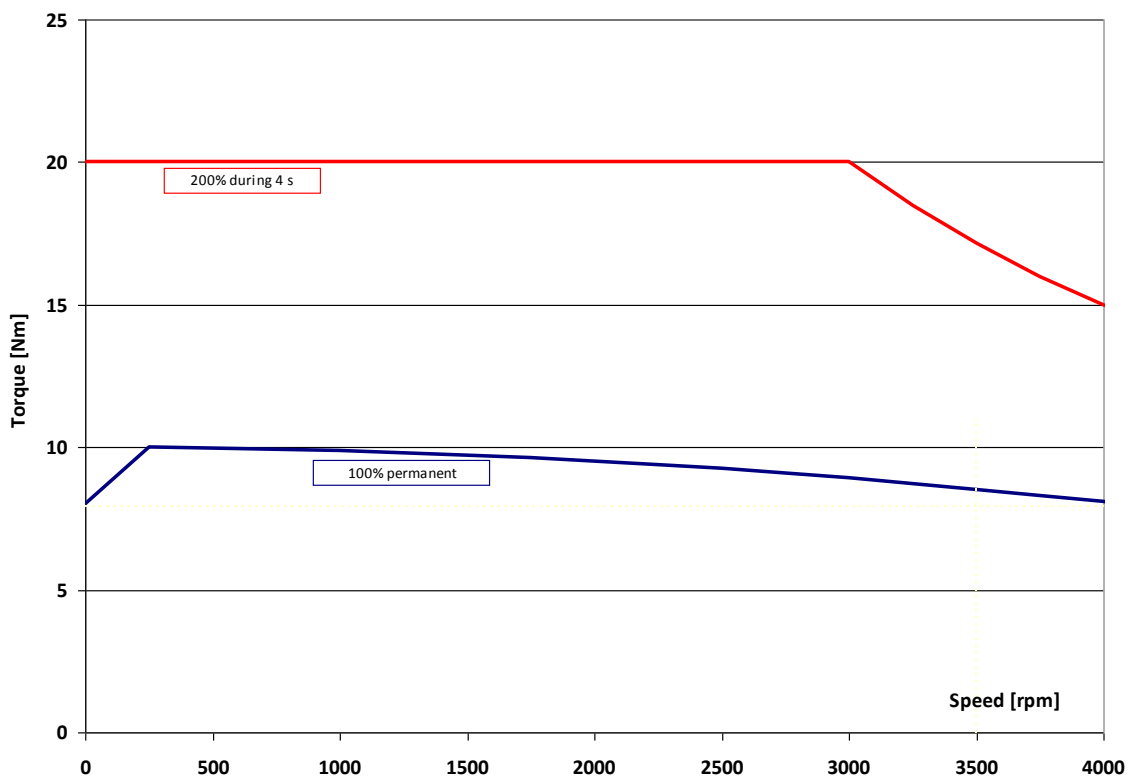



Example n°1 :

The application needs:

- a rms torque of **7 Nm** at the rms speed of **2000 rpm**,
- an acceleration torque of **12 Nm**,
- a maximal speed of **2800 rpm**.

Selection of the motor:

The selected motor is the type **NX620EAR**.

The nominal speed is equals to 3900 rpm.

The maximal speed is equals to 3900 rpm.

The torque sensitivity is equals to 1.47 Nm/Arms.

BRUSHLESS MOTORS			
NX620EAR			
ELECTRONIC DRIVE (1)			
DIGIVEX 7.5/15 et DIGIVEX 8/16			
	(230V) (400V) (480V)		

Torque at low speed	M_0	Nm	8	
Permanent current at low speed	I_0	A_{rms}	5.31	
Peak torque	M_p	Nm	26.7	--
Current for the peak torque	I_p	A_{rms}	21.2	--
Back emf constant at 1000 rpm (25°C)*	K_e	V_{rms}	95.7	
Torque sensitivity	K_t	Nm/A_{rms}	1.51	
Winding resistance (25°C)*	R_b	Ω	2.24	
Winding inductance*	L	mH	19.2	
Rotor inertia	J	$kgm^2 \times 10^{-5}$	98	
Thermal time constant	T_{th}	min	27	
Motor mass	M	kg	7	
Voltage of the mains	UR1 UR2 UR3	V_{rms}	230	400 480
Rated speed	Nr1 Nr2 Nr3	rpm	2200	3900 4500
Rated torque	Mn1 Mn2 Mn3	Nm	7.42	6.17 5.57
Rated current	In1 In2 In3	A_{rms}	4.99	4.25 3.89
Rated power	Pn1 Pn2 Pn3	W	1710	2520 2620

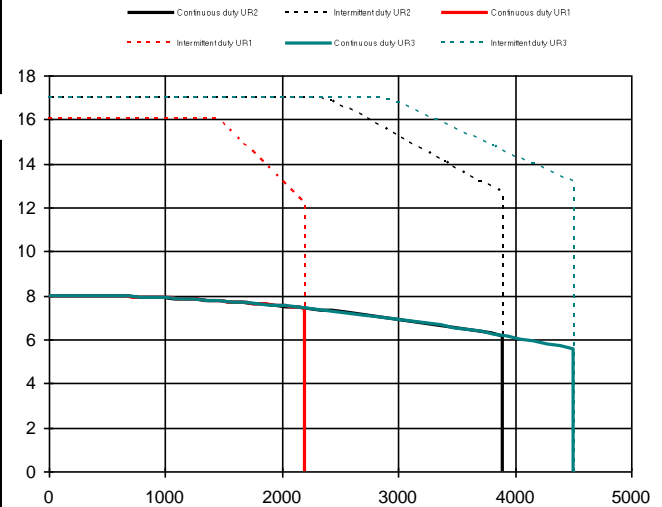

The permanent current I_0 of the motor is **5.31 Arms** for $M_0=8 Nm$ at low speed.

The nominal current I_n of the motor is **4.25 Arms** for $M_n=6.17 Nm$ at the nominal speed.

Selection of the drive:

The drive has to provide at least a permanent current equals to I_0 (5.31 Arms).

In order to obtain an acceleration torque of **12 Nm**, the current will be about 8 Arms (the motor data sheet shows 17 Nm with 11.3 Arms). This means that the drive has to provide at least 8 Arms as transient current.

→ Therefore, we can select the drive **AC890SD-53 2100 B** which delivers under 400 VAC:

6 Arms as permanent current and

$6 \times 200\% = 12$ Arms as maximal transient current during 4 s.

The drive is set with **“Servo Mode”**.

→ We also can select the drive **DIGIVEX 8/16 Â** which delivers under 400 VAC:

5.6 Arms as permanent current and

$5.6 \times 200\% = 11.3$ Arms as maximal transient current during 2 s.



Example n°2 :

This times; the application needs :

- a permanent torque of **5.8 Nm** at low speed,
- a rms torque of **5.8 Nm** at the rms speed of **1890 rpm**,
- an acceleration torque of **8.8 Nm**,
- a maximal speed of **2800 rpm**.

Selection of the motor:

The selected motor is the type **NX620EAR**.

The nominal speed is equals to 3900 rpm.

The maximal speed is equals to 3900 rpm.

The torque sensitivity is equals to 1.47 Nm/Arms.

Selection of the drive:

The drive has to provide a permanent current equals to 4 Arms to obtain 5.8 Nm.

In order to obtain an acceleration torque of **8.8 Nm**, the current will be of about 6 Arms

This means that the drive has to provide at less 6 Arms as transient current.

Compared to the previous example n°1, it is now possible to decrease the size of drive.

→ Therefore, we can select the drive **AC890SD-53 1600 B** which delivers under 400 VAC:

4 Arms as permanent current and

4*200%=8 Arms as maximal transient current during 4 s.

The drive is set with "**Servo Mode**".

3.1.5. Current limitation at stall conditions (i.e. speed < 3 rpm)

Recommended reduced current at speed < 3 rpm:

$$I_{reduced} = \frac{1}{\sqrt{2}} * I_0 \cong 0.7 * I_0$$

	<p>Warning: The current must be limited to the prescribed values. If the nominal torque has to be maintained at stop or low speed (< 3 rpm), imperatively limit the current to 70% of I_0 (permanent current at low speed), in order to avoid an excessive overheating of the motor.</p>
	<p>Please refer to the drive technical documentation for any further information and to choose functions to program the drive.</p>

3.1.6. Peak current limitations

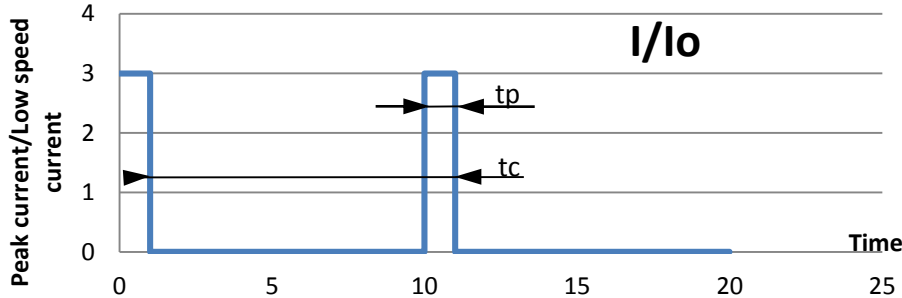

It is possible to use the NX motor with a current higher than the permanent current. But, to avoid any overheating, the following rules must be respected.

- 1) The peak currents and peak torques given in the data sheet must never be exceeded
- 2) The thermal equivalent torque must be respected (§3.1.3)
- 3) If 1) and 2) are respected (it can limit the peak current value or duration), the peak current duration (t_p) must be limited, in addition, accordingly to the following table (I_0 is the permanent current at low speed):

I_{peak}/I_n	$I_p/I_0 = 2$	$I_p/I_0 = 3$	$I_p/I_0 = 4$	$I_p/I_0 > 5$
NX110	$t_p < 0.8$ s	$t_p < 0.3$ s	$t_p < 0.15$ s	$t_p < 0.1$ s
NX210				
NX310				
NX420				
NX430	$t_p < 1.5$ s	$t_p < 0.6$ s	$t_p < 0.3$ s	$t_p < 0.2$ s
NX620				
NX630				
NX820				
NX840	$t_p < 3$ s	$t_p < 1.5$ s	not allowed	
NX860				
NX860V				
NX860W				

The peak current duration is calculated for a temperature rise of 3°C
Consult us for more demanding applications.

3.2. NX Characteristics: Torque, speed, current, power...

The torque vs speed graph below explains different intrinsic values of the next tables.

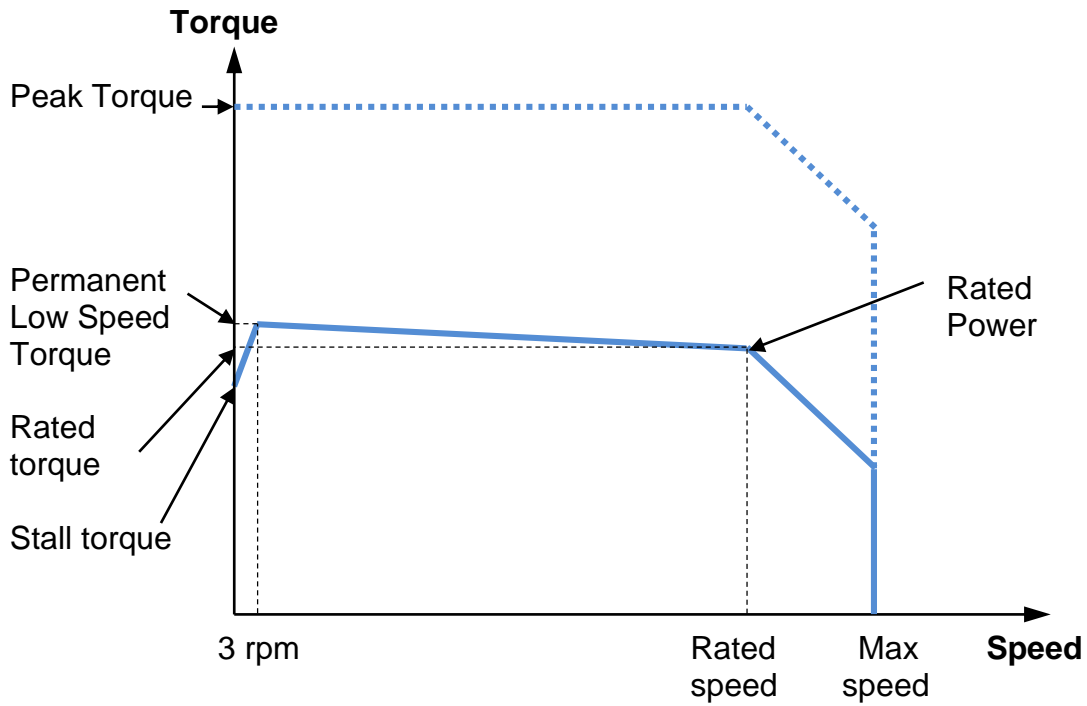



3.2.1. NX datas – Mains voltage 230V

Motor	Rated Power Pn (kW)	Rated Torque Mn (Nm)	Rated Current In [Arms]	Low speed torque Mo [Nm]	Low speed Current Io [Arms]	Peak Torque Mpeak [Nm]	Peak Current I peak [Arms]	Max. Speed Nmax [rpm]
230VAC power supply - single or three-phased – natural cooling								
NX110E_P	0,21	0,33	0,79	0,45	1,0	1,7	4,0	6000
NX110A_J	0,05	0,09	0,34	0,31	1,0	0,9	2,8	5000
NX205E_V	0,19	0,37	0,86	0,45	1,0	2,0	5,1	5000
NX205E_S	0,23	0,29	0,96	0,45	1,4	2,0	7,0	7500
NX210A_T	0,17	0,41	0,61	0,7	1,0	1,9	2,8	4000
NX210E_T	0,33	0,80	1,11	1	1,3	3,4	5,4	4000
NX210E_P	0,39	0,61	1,32	1	2,0	3,4	8,0	6000
NX310E_P	0,43	1,80	1,27	2	1,4	6,6	5,6	2300
NX310E_K	0,69	1,65	2,06	2	2,4	6,6	9,7	4000
NX310E_I	0,87	1,48	2,61	2	3,4	6,6	13,5	5600
NX310E_X	0,91	1,32	2,71	2	3,9	6,6	15,4	6600
NX420E_V	0,36	3,83	1,30	4	1,4	13,4	5,5	900
NX420E_P	0,85	3,53	2,41	4	2,7	13,4	10,9	2300
NX420E_J	1,31	3,14	3,74	4	4,7	13,4	18,9	4000
NX420E_X	1,48	3,29	4,53	4	5,4	13,4	21,8	4300
NX430E_V	0,31	5,45	1,40	5,5	1,4	18,7	5,6	550
NX430E_P	0,93	5,22	2,69	5,5	2,8	18,7	11,3	1700
NX430E_L	1,21	5,04	3,49	5,5	3,8	18,7	15,1	2300
NX430E_J	1,57	4,68	4,53	5,5	5,2	18,7	21,0	3200
NX430E_H	1,64	4,59	4,78	5,5	5,6	18,7	22,6	3400
NX430E_F	1,80	4,29	5,28	5,5	6,6	18,7	26,6	4000
NX620E_V	0,91	7,85	2,79	8	2,8	26,6	11,3	1100
NX620E_R	1,71	7,42	4,99	8	5,3	26,6	21,2	2200
NX620E_J	2,55	6,08	7,82	8	9,9	26,6	39,5	4000
NX620E_D	2,63	5,12	8,23	8	12,1	26,6	48,3	4900
NX630E_V	0,89	11,40	2,51	12	2,6	39,9	10,5	750
NX630E_R	1,63	10,70	4,75	12	5,3	39,9	21,0	1450
NX630E_N	2,36	9,81	6,63	12	7,9	39,9	31,7	2300
NX630E_K	2,70	9,21	7,80	12	9,9	39,9	39,4	2800
NX630E_G	3,48	8,31	10,10	12	13,9	39,9	55,7	4000
NX820E_X	1,61	15,40	4,99	16	5,2	49,9	20,3	1000
NX820E_R	3,34	14,50	10,00	16	11,0	49,9	43,2	2200
NX820E_L	4,99	13,20	14,80	16	17,6	49,9	69,2	3600
NX840E_Q	3,21	25,50	9,27	28	10,1	91,8	39,9	1200
NX840E_L	4,32	24,30	13,30	28	15,1	91,8	59,8	1700
NX840E_K	4,91	23,50	14,30	28	16,8	91,8	66,5	2000
NX840E_J	5,27	22,90	15,70	28	18,9	91,8	74,8	2200
NX860E_J	5,40	35,60	16,20	41	18,5	136,5	74,0	1450
NX860E_F	6,53	32,80	21,80	41	27,0	136,5	107,6	1900
NX860E_D	7,48	27,50	22,50	41	33,0	136,5	131,6	2600
NX860V_J	8,99	59,20	27,10	64	29,3	136,5	74,0	1450
NX860V_F	11,80	56,40	37,50	64	42,7	136,5	107,6	2000
230 VAC power supply - three-phased - water cooled								
NX860W_F	18,50	88,30	61,50	90	62,6	137,0	108,3	2000
NX860W_D	23,10	87,40	74,50	90	76,5	137,0	132,4	2600



3.2.2. NX datas – Mains voltage 400V

Motor	Rated Power Pn (kW)	Rated Torque Mn (Nm)	Rated Current In [Arms]	Low speed torque Mo [Nm]	Low speed Current Io [Arms]	Peak Torque Mpeak [Nm]	Peak Current I peak [Arms]	Max. Speed Nmax [rpm]
400 VAC power supply - three-phased – Natural cooling								
NX205E_V	0,225	0,287	0,7	0,45	1,0	2,0	5,1	7500
NX205E_S	0,214	0,229	0,8	0,45	1,4	2,0	7,0	8900
NX210A_T	0,0969	0,154	0,3	0,7	1,0	1,9	2,8	6000
NX210E_T	0,385	0,613	0,9	1	1,3	3,4	5,4	6000
NX210E_P	0,366	0,499	1,1	1	2,0	3,4	8,0	7000
NX310E_P	0,689	1,65	1,2	2	1,4	6,6	5,6	4000
NX310E_K	0,997	1,36	1,8	2	2,4	6,6	9,7	7000
NX310E_I	0,9	1,07	2,0	2	3,4	6,6	13,5	8000
NX310E_X	0,9	1,07	2,3	2	3,9	6,6	15,4	8000
NX420E_V	0,753	3,6	1,2	4	1,4	13,4	5,5	2000
NX420E_P	1,31	3,14	2,2	4	2,7	13,4	10,9	4000
NX420E_J	1,65	2,62	3,2	4	4,7	13,4	18,9	6000
NX420E_X	1,49	1,89	2,7	4	5,4	13,4	21,8	7500
NX430E_V	0,563	5,38	1,4	5,5	1,4	18,7	5,6	1000
NX430E_P	1,5	4,77	2,5	5,5	2,8	18,7	11,3	3000
NX430E_L	1,8	4,29	3,0	5,5	3,8	18,7	15,1	4000
NX430E_J	1,93	3,35	3,3	5,5	5,2	18,7	21,0	5500
NX430E_H	1,87	2,98	3,2	5,5	5,6	18,7	22,6	6000
NX430E_F	1,87	2,98	3,8	5,5	6,6	18,7	26,6	6000
NX620E_V	1,57	7,52	2,7	8	2,8	26,6	11,3	2000
NX620E_R	2,52	6,17	4,3	8	5,3	26,6	21,2	3900
NX620E_J	2,45	4,1	5,6	8	9,9	26,6	39,5	5700
NX620E_D	2,31	3,68	6,2	8	12,1	26,6	48,3	6000
NX630E_V	1,53	10,8	2,4	12	2,6	39,9	10,5	1350
NX630E_R	2,64	9,34	4,2	12	5,3	39,9	21,0	2700
NX630E_N	3,18	7,6	5,3	12	7,9	39,9	31,7	4000
NX630E_K	3,19	6,23	5,5	12	9,9	39,9	39,4	4900
NX630E_G	1,89	2,86	4,0	12	13,9	39,9	55,7	6300
NX820E_X	2,93	14,7	4,8	16	5,2	49,9	20,3	1900
NX820E_R	5,29	12,9	9,1	16	11,0	49,9	43,2	3900
NX820E_L	6,72	10,4	11,9	16	17,6	49,9	69,2	6200
NX840E_Q	5,09	23,2	8,5	28	10,1	91,8	39,9	2100
NX840E_L	6,49	20	11,1	28	15,1	91,8	59,8	3100
NX840E_K	6,8	18,6	11,5	28	16,8	91,8	66,5	3500
NX840E_J	6,96	17	12,0	28	18,9	91,8	74,8	3900
NX860E_J	7,48	27,5	12,7	41	18,5	136,5	74,0	2600
NX860E_F	7,34	21,9	14,9	41	27,0	136,5	107,6	3200
NX860E_D	7,34	21,9	18,2	41	33,0	136,5	131,6	3200
NX860V_J	14,3	52,6	24,1	64	29,3	136,5	74,0	2600
NX860V_F	17	43,4	28,9	64	42,7	136,5	107,6	3750
400 VAC power supply - three-phased - water cooled								
NX860W_F	33,4	85,1	59,3	90	62,6	137	108,3	3750
NX860W_D	38,6	83,7	71,3	90	76,5	137	132,4	4400

3.2.3. Further Data

Motor	Ke [Vrms/krpm]	Kt (sine) [Nm/Arms]	Winding Resistance [ohms]	Inductance [mH]	Moment of Inertia J [kgmm ²]	Motor Weight without brake [kg]	Water Flow [l/min]
NX110A_J	22,4	0,318	12,00	14,9	13	0,8	-
NX110E_P	29,9	0,455	22,60	26,5	13	0,8	-
NX205E_S	21,9	0,322	8,89	24,3	21	0,8	-
NX205E_V	30,2	0,444	17,60	46,4	21	0,8	-
NX210A_T	48,6	0,701	16,30	35,0	38	1,1	-
NX210E_P	32,6	0,503	7,74	15,8	38	1,1	-
NX210E_T	48,6	0,749	16,30	35,0	38	1,1	-
NX310E_I	36,5	0,591	3,41	10,5	79	2,0	-
NX310E_K	50,9	0,823	6,58	20,3	79	2,0	-
NX310E_P	88,9	1,440	20,70	62,0	79	2,0	-
NX310E_X	32,1	0,519	2,68	8,1	79	2,0	-
NX420E_J	51,9	0,853	2,31	11,0	290	3,7	-
NX420E_P	89,9	1,480	7,20	33,0	290	3,7	-
NX420E_V	179,0	2,940	28,40	131,0	290	3,7	-
NX420E_X	44,9	0,738	1,78	8,2	290	3,7	-
NX430E_F	51,8	0,828	1,38	6,8	426	4,5	-
NX430E_H	61,0	0,975	1,81	9,4	426	4,5	-
NX430E_J	65,6	1,050	2,19	10,9	426	4,5	-
NX430E_L	90,9	1,450	4,22	21,0	426	4,5	-
NX430E_P	122,0	1,950	7,26	37,8	426	4,5	-
NX430E_V	244,0	3,900	29,00	151,0	426	4,5	-
NX620E_D	42,0	0,662	0,44	3,7	980	6,9	-
NX620E_J	51,3	0,809	0,60	5,5	980	6,9	-
NX620E_R	95,7	1,510	2,24	19,2	980	6,9	-
NX620E_V	180,0	2,830	7,90	67,6	980	6,9	-
NX630E_G	52,1	0,861	0,34	3,5	1 470	8,0	-
NX630E_K	73,6	1,220	0,67	7,1	1 470	8,0	-
NX630E_N	91,6	1,510	1,12	10,9	1 470	8,0	-
NX630E_R	138,0	2,290	2,43	24,9	1 470	8,0	-
NX630E_V	277,0	4,570	9,19	99,6	1 470	8,0	-
NX820E_L	56,9	0,911	0,38	3,4	3 200	13,0	-
NX820E_R	91,0	1,460	1,01	8,6	3 200	13,0	-
NX820E_X	193,0	3,100	4,53	38,7	3 200	13,0	-
NX840E_J	92,8	1,480	0,37	4,3	6 200	20,0	-
NX840E_K	104,0	1,670	0,49	5,4	6 200	20,0	-
NX840E_L	116,0	1,850	0,58	6,7	6 200	20,0	-
NX840E_Q	174,0	2,780	1,36	15,1	6 200	20,0	-
NX860E_D	78,7	1,240	0,16	2,0	9 200	27,0	-
NX860E_F	96,1	1,520	0,24	3,0	9 200	27,0	-
NX860E_J	140,0	2,210	0,50	6,4	9 200	27,0	-
NX860V_F	96,1	1,500	0,24	3,0	9 200	30,5	-
NX860V_J	140,0	2,180	0,50	6,4	9 200	30,5	-
NX860W_D	78,7	1,180	0,16	2,0	9 200	27,5	5,0
NX860W_F	96,1	1,440	0,24	3,0	9 200	27,5	11,8

3.2.4. Efficiency curves



Caution: The efficiency curves are typical values. They may vary from one motor to another



Caution: The efficiency curves are given for an optimal motor control (no voltage saturation and optimal phase between current and EMF)



Caution: The efficiency curves do not include the losses due to the switching frequency.



3.2.4.1. Series NX110E

Constant efficiency curves of the motor
NX110EAP

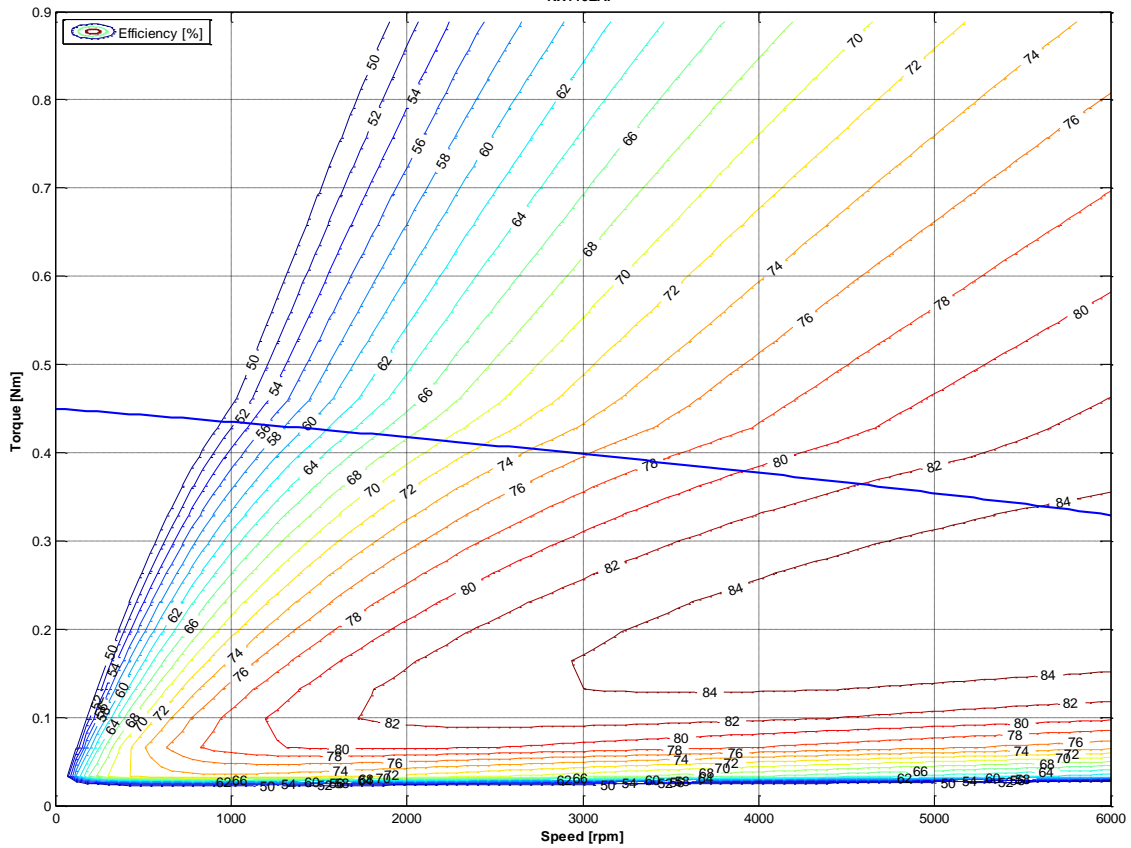

3.2.4.2. Series NX205E

Constant efficiency curves of the motor
NX205E

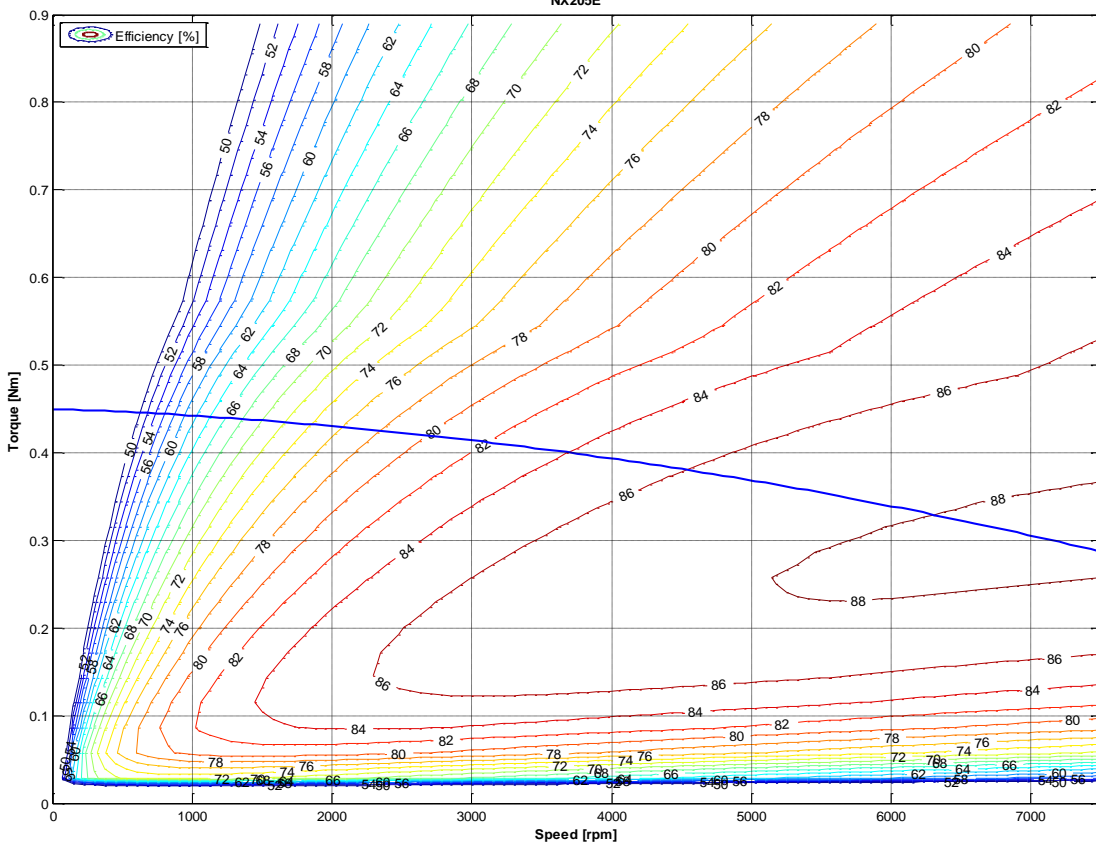



3.2.4.3. Series NX210E

Constant efficiency curves of the motor
NX210E

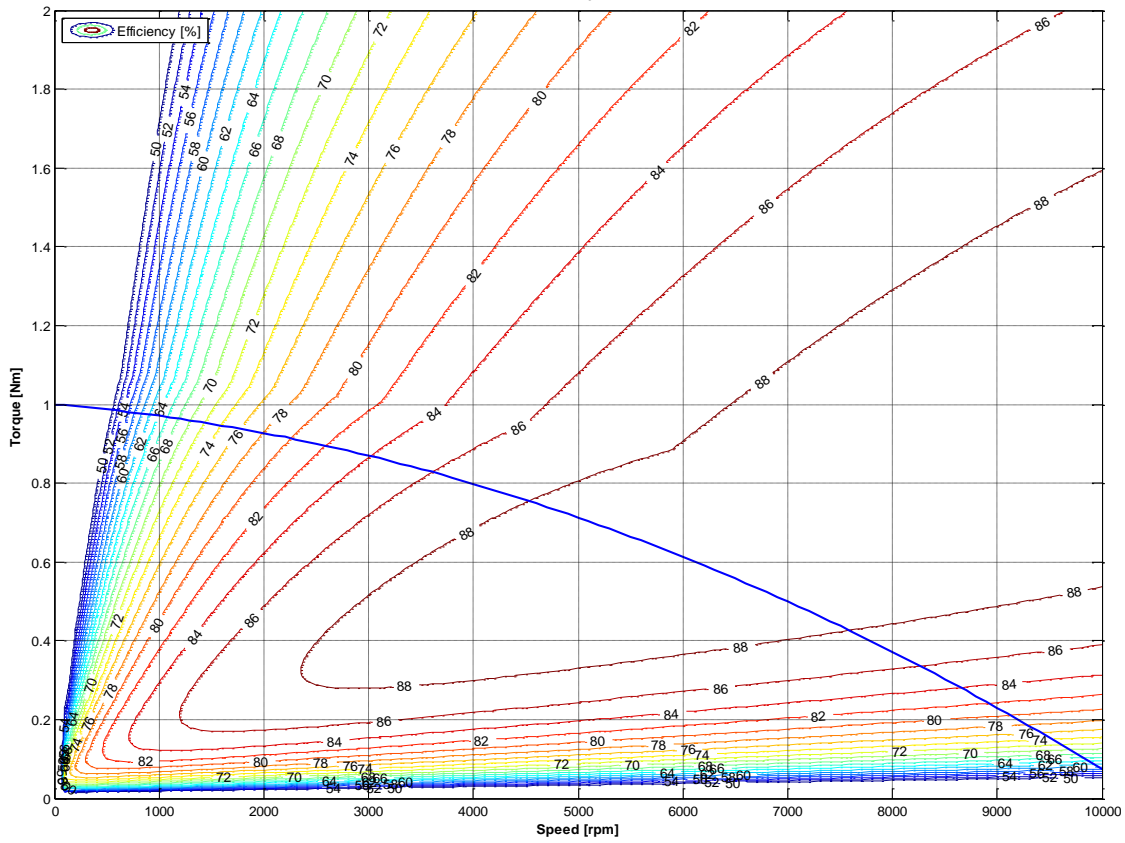

3.2.4.4. Series NX310E

Constant efficiency curves of the motor
NX310E

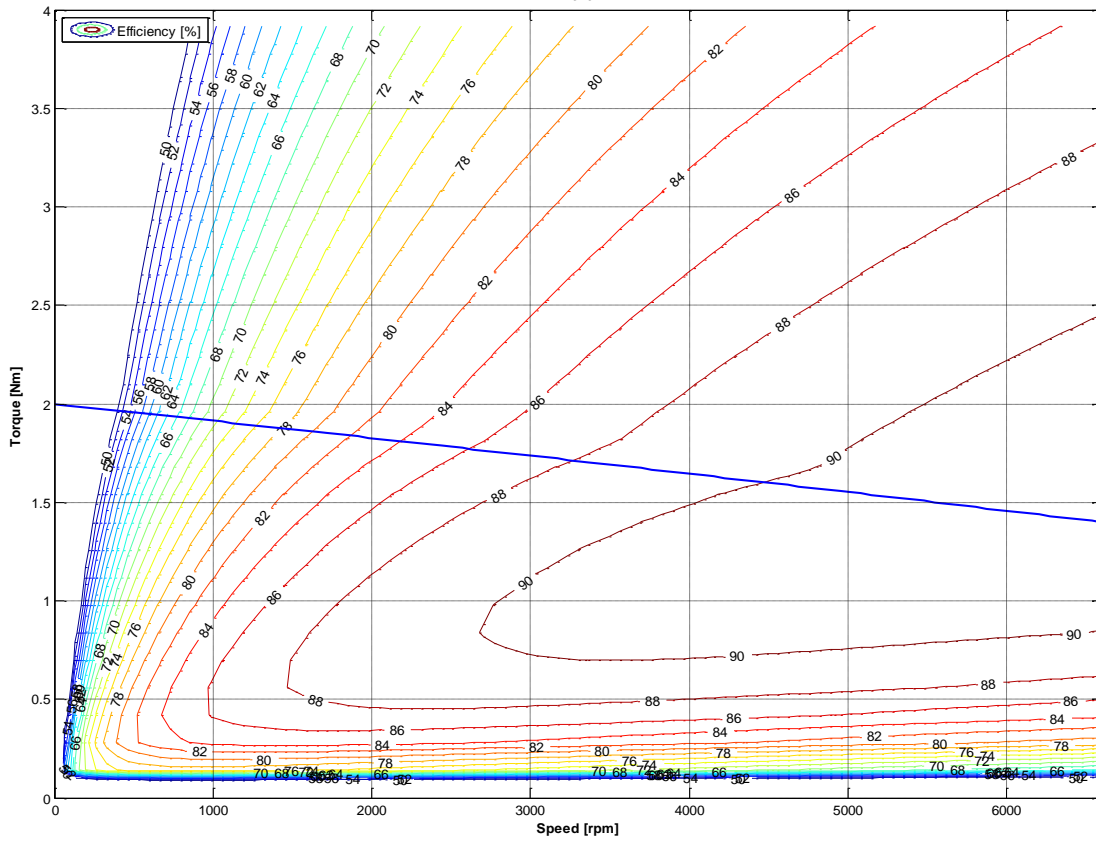



3.2.4.5. Series NX420E

Constant efficiency curves of the motor
NX420E

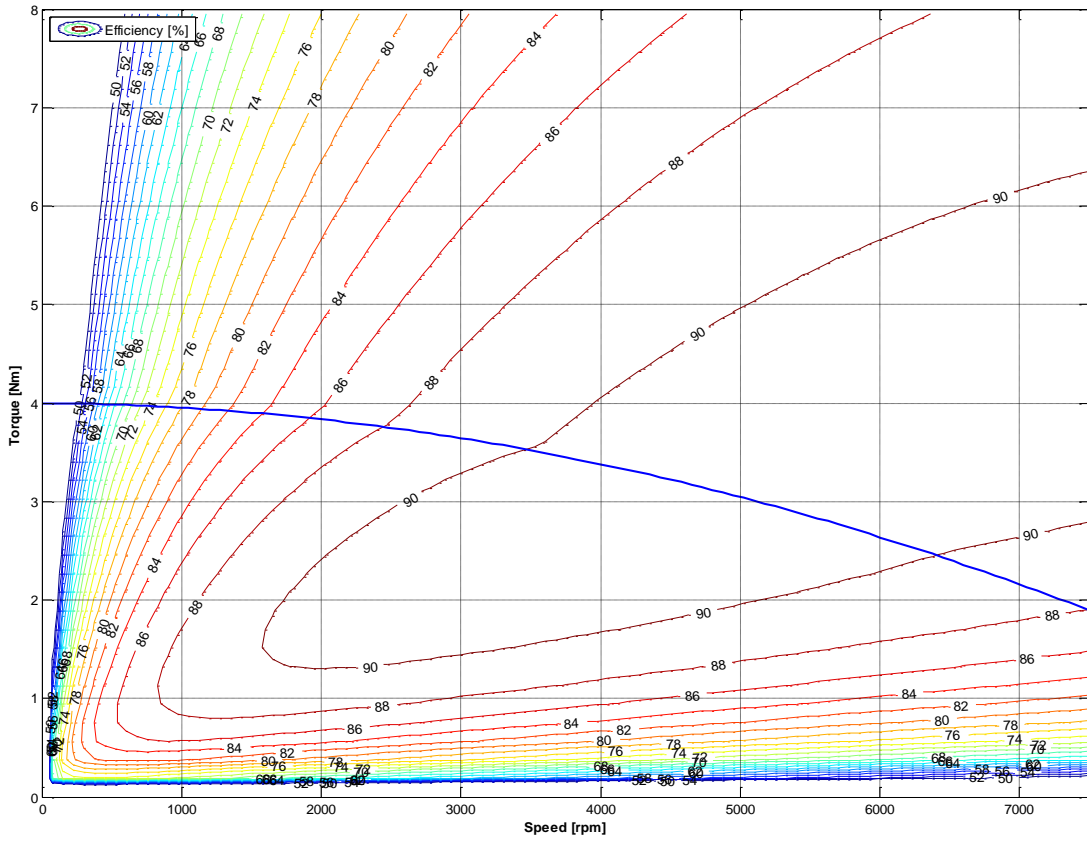

3.2.4.6. Series NX430E

Constant efficiency curves of the motor
NX430E

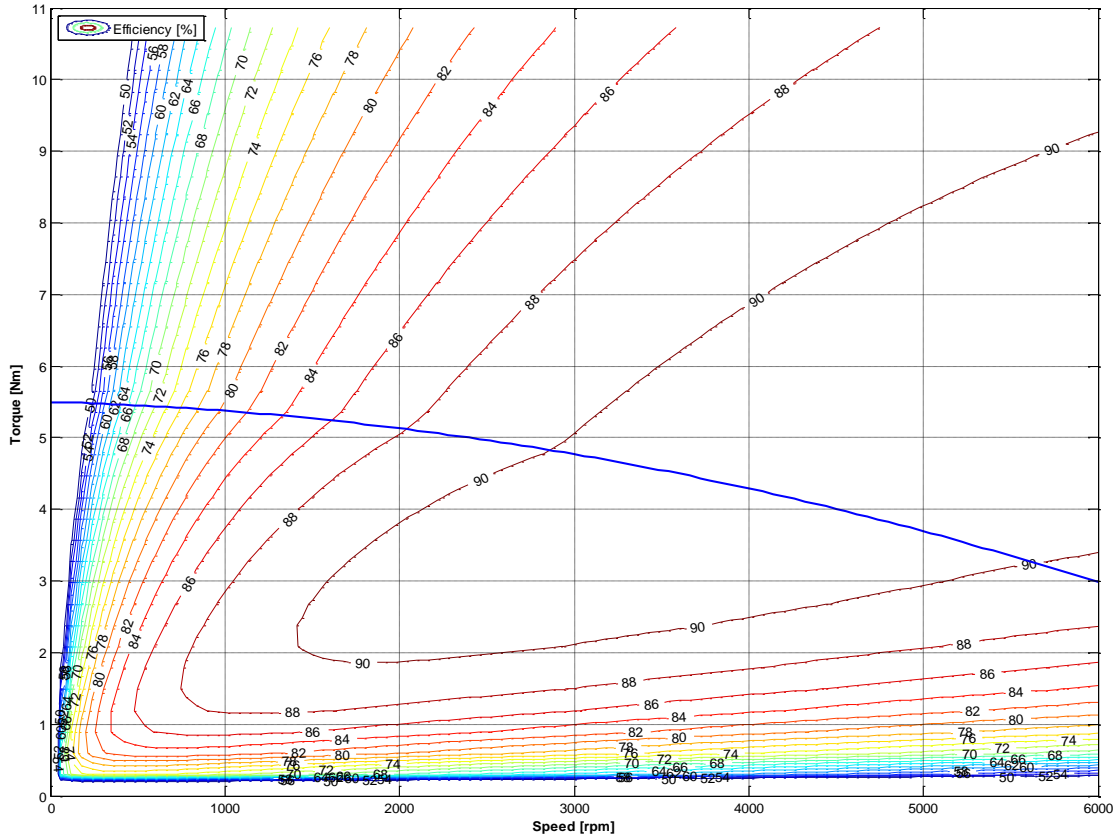



3.2.4.7. Series NX620E

Constant efficiency curves of the motor
NX620E

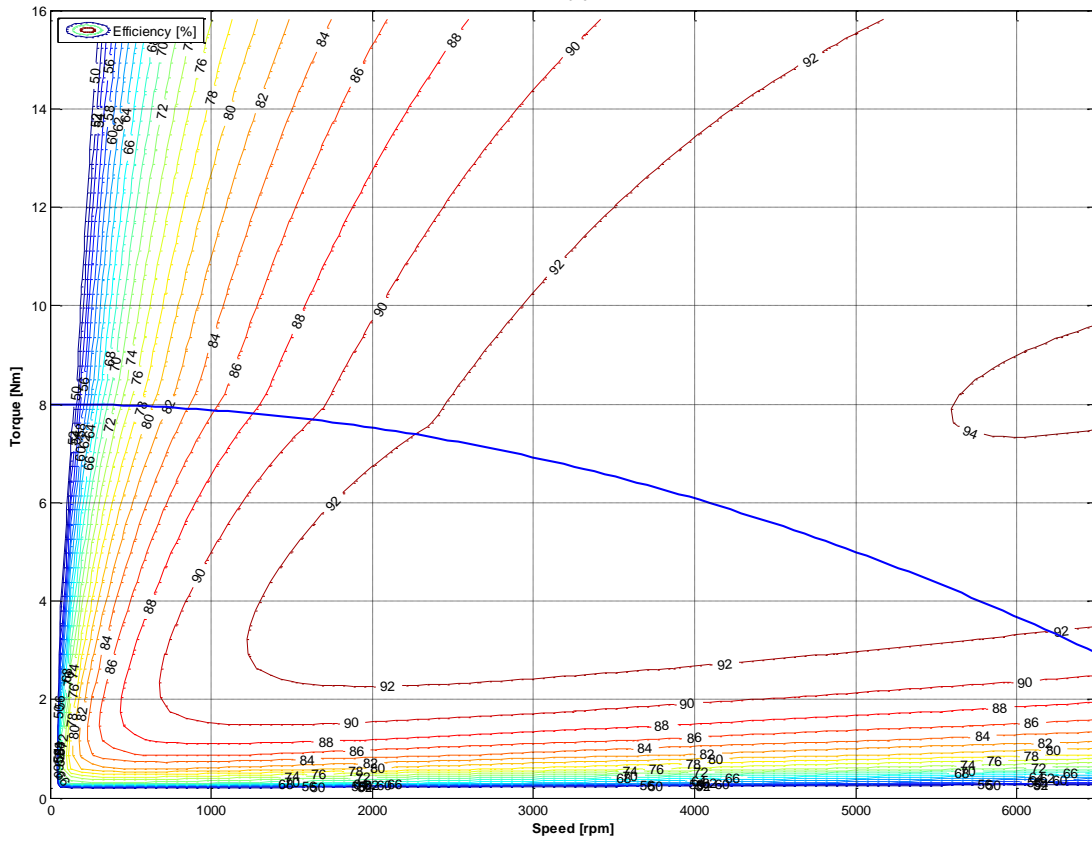

3.2.4.8. Series NX630E

Constant efficiency curves of the motor
NX630E

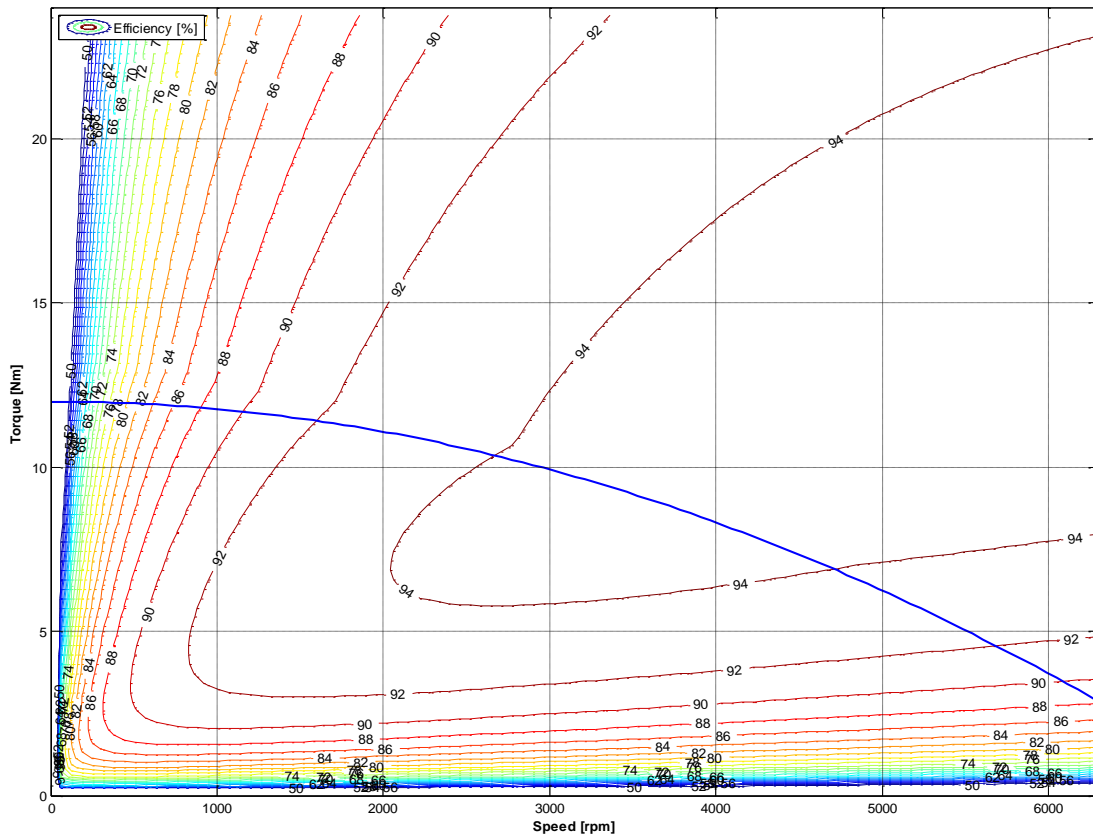



3.2.4.9. Series NX820E

Constant efficiency curves of the motor
NX820E

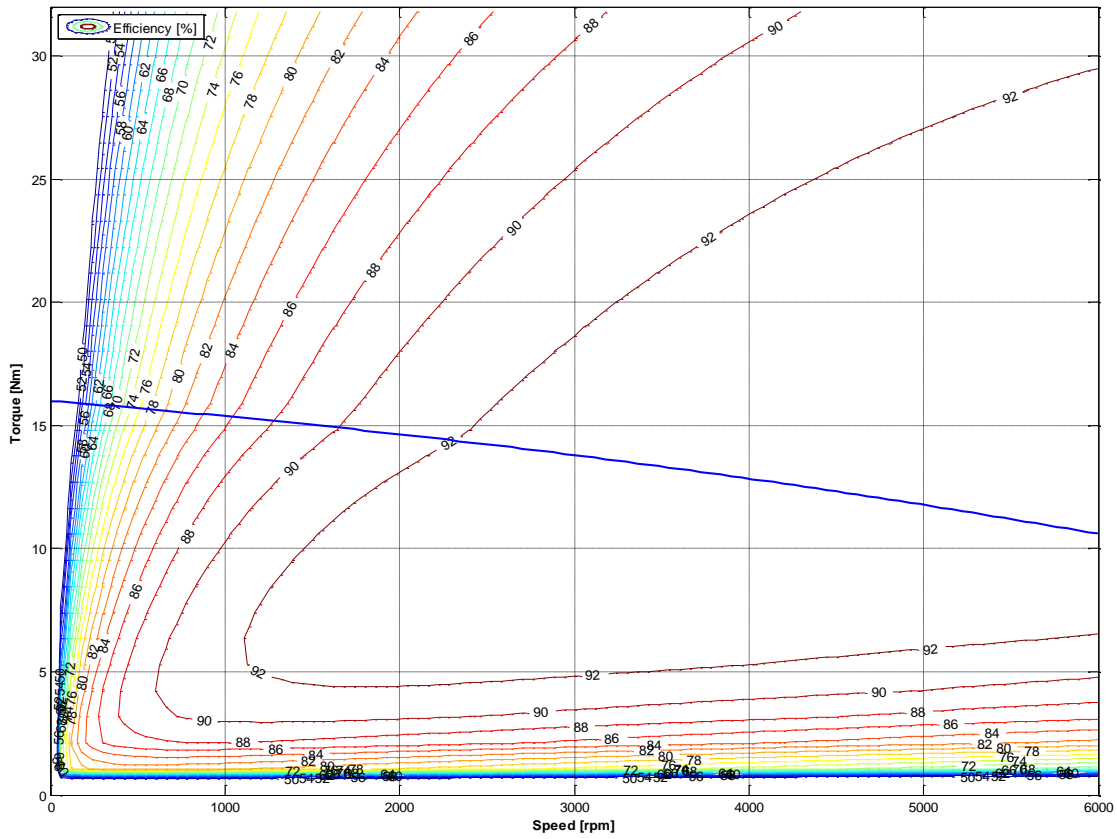

3.2.4.10. Series NX840E

Constant efficiency curves of the motor
NX840E

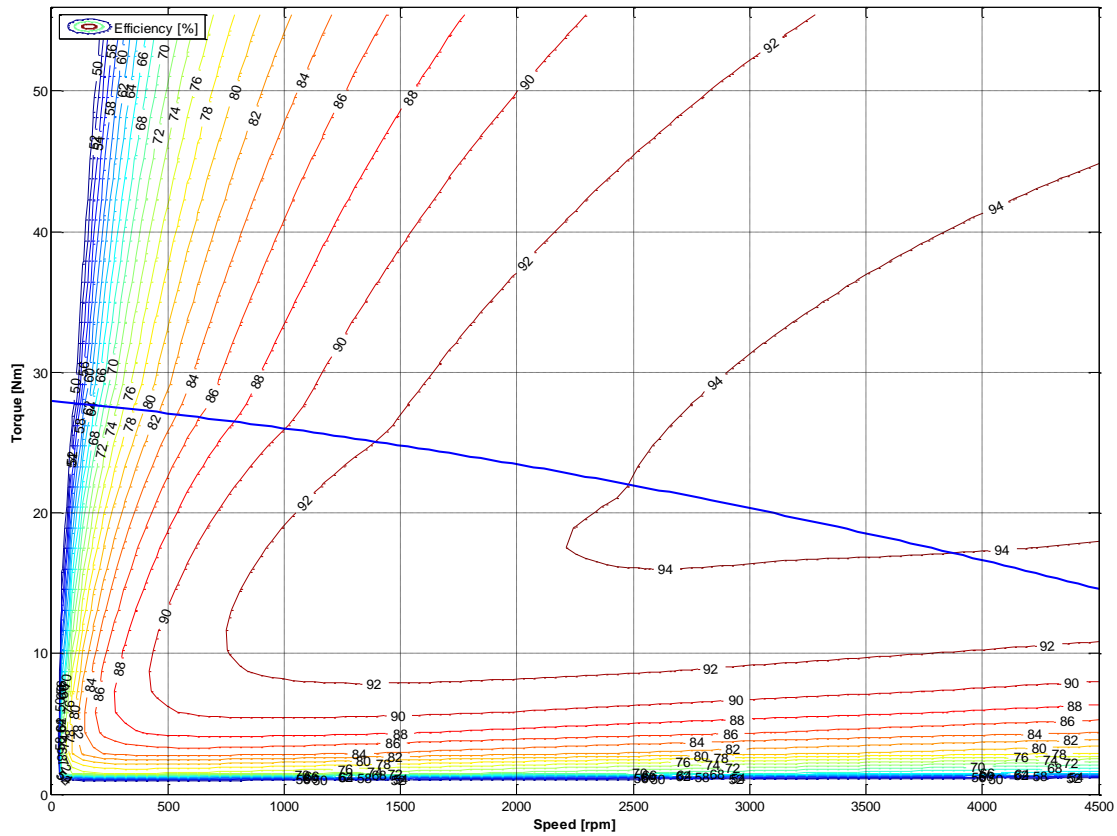



3.2.4.11. Series NX860E

Constant efficiency curves of the motor
NX860E

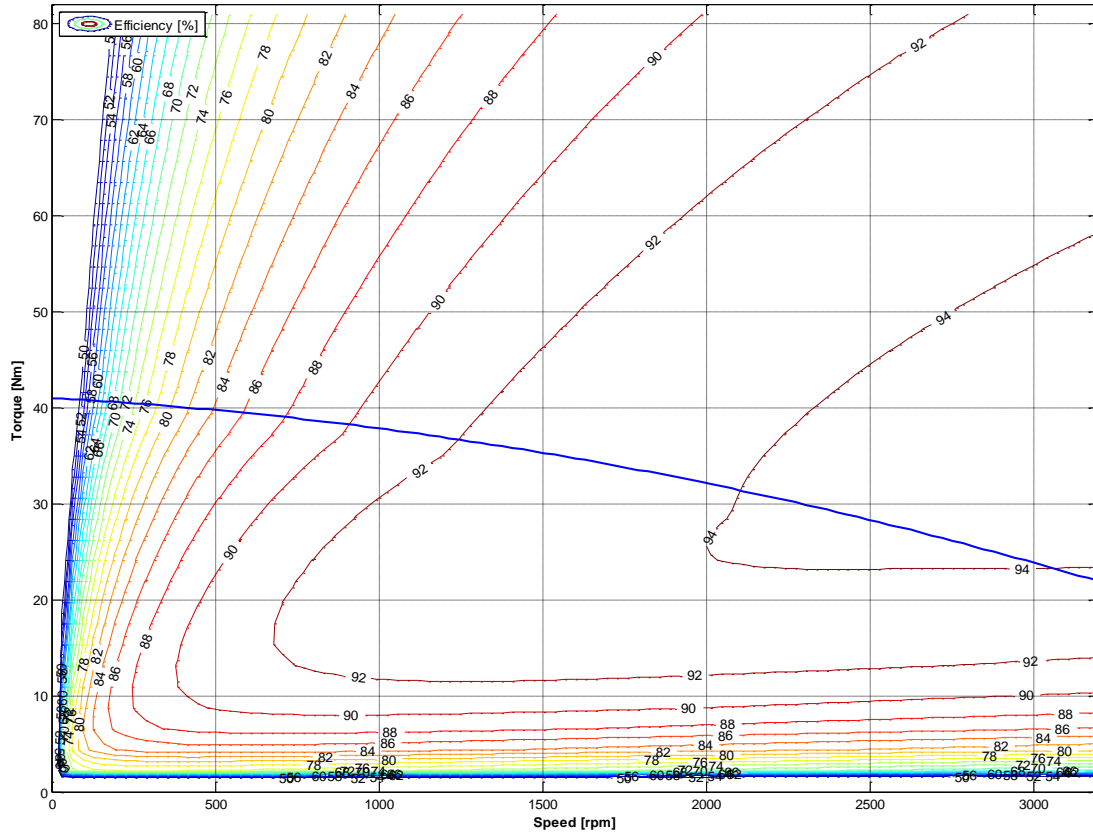



3.2.4.12. Series NX860V

Constant efficiency curves of the motor
NX860V

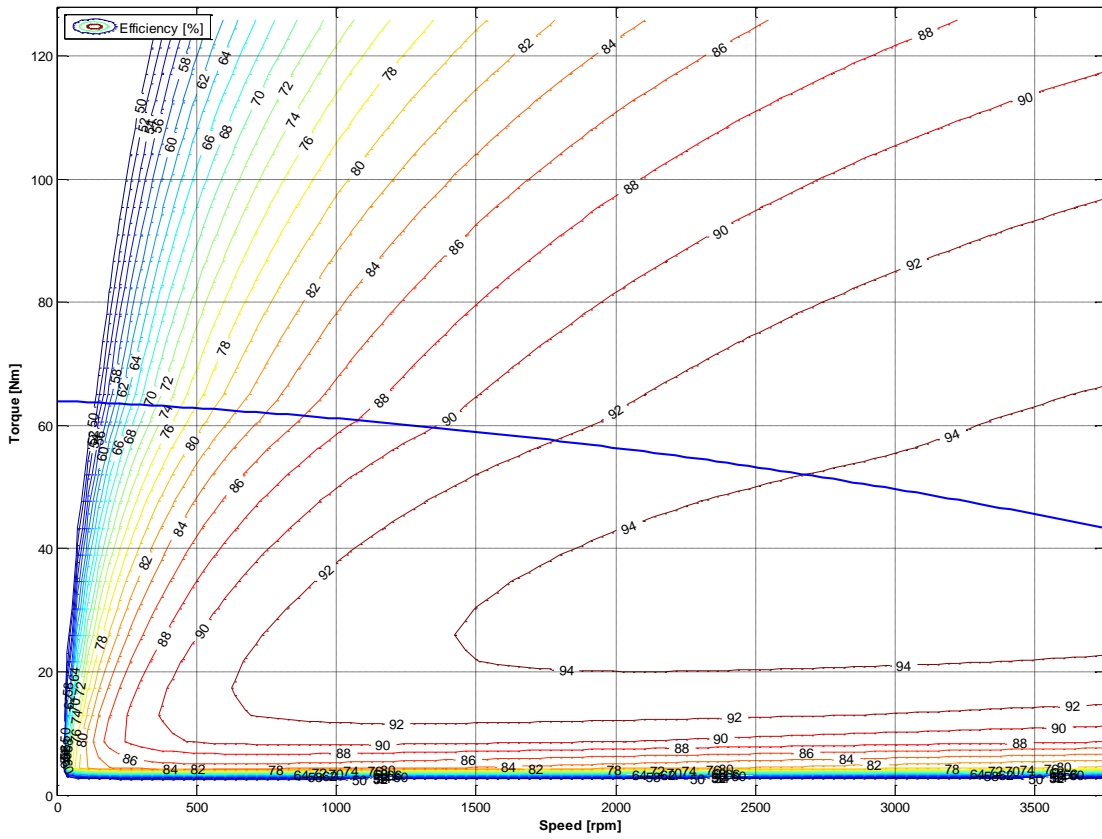

3.2.4.13. Series NX860W

Constant efficiency curves of the motor
NX860W

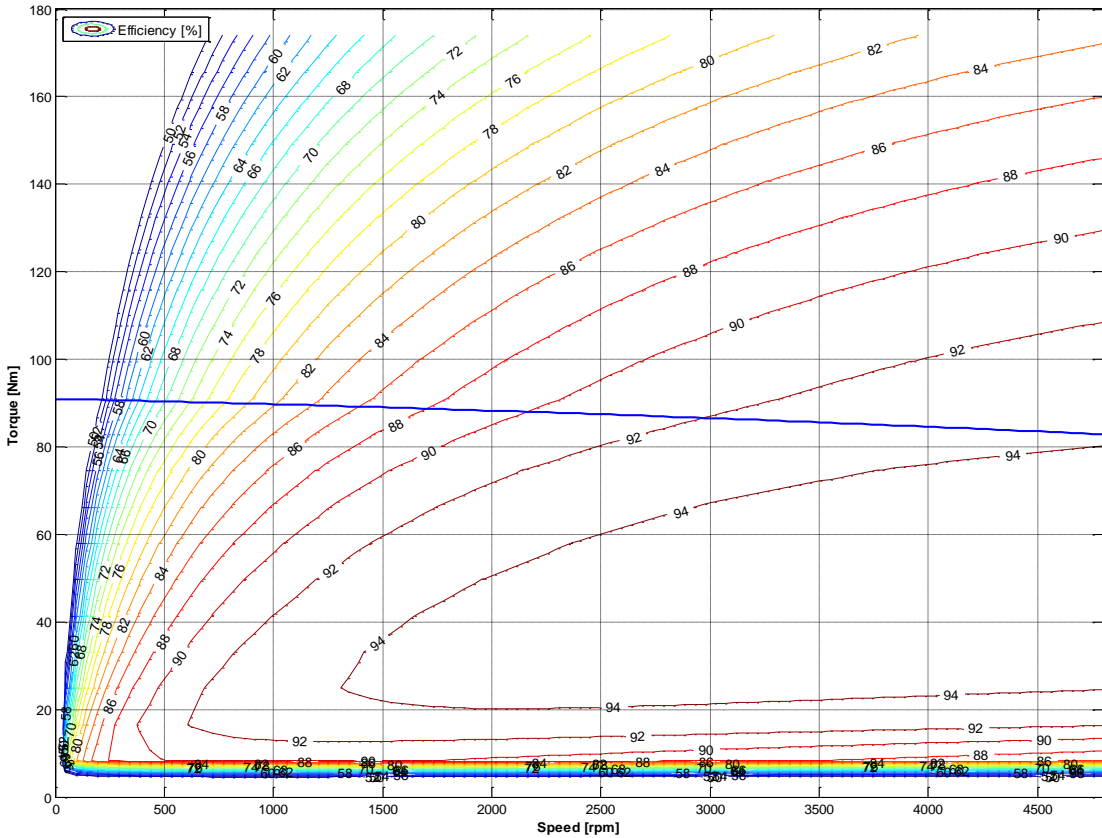

3.2.5. Electromagnetic losses



Caution: Following data result from our best estimations but are indicative. They can vary from one motor to another and with temperature. No responsibility will be accepted for direct or indirect losses or damages due to the use of these data.

(Following data are indicative)

Type	Tf [Nm]	Kd [Nm/1000rpm]
NX110EAP	0.050	0.001
NX205EAV	0.050	0.010
NX210EAP	0.055	0.024
NX310EAP	0.067	0.033
NX420EAP	0.090	0.114
NX430EAP	0.106	0.149
NX620EAR	0.106	0.196
NX630EAR	0.131	0.245
NX820EAR	0.160	0.300
NX840EAK	0.190	0.380
NX860EAJ	0.220	0.460

Torque losses = Tf + Kd x speed/1000

3.2.6. Time constants of the motor

3.2.6.1. Electric time constant:

$$\tau_{elec} = \frac{L_{ph_ph}}{R_{ph_ph}}$$

With following values given in the motor data sheet
 L_{ph_ph} inductance of the motor phase to phase [H],
 R_{ph_ph} resistance of the motor phase to phase at 25°C [Ohm].

Example:

Motor series NX620EAR

$L_{ph_ph} = 19.2 \text{ mH}$ or $19.2 \cdot 10^{-3} \text{ H}$

R_{ph_ph} at 25°C = 2.24 Ohm

→ $\sigma_{elec} = 19.2 \cdot 10^{-3} / 2.24 = \mathbf{8.6 \text{ ms}}$

An overall summary of motor time constants is given a little further.

3.2.6.2. Mechanical time constant:

$$\tau_{mech} = \frac{R_{ph_n} * J}{Kt * Ke_{ph_n}} = \frac{0.5 * R_{ph_ph} * J}{(3 * \frac{Ke_{ph_ph}}{\sqrt{3}}) * \frac{Ke_{ph_ph}}{\sqrt{3}}}$$

$$\tau_{mech} = \frac{0.5 * R_{ph_ph} * J}{(Ke_{ph_ph})^2}$$

With following values obtained from the motor data sheet:

R_{ph_ph} resistance of the motor phase to phase at 25°C [Ohm],

J inertia of the rotor [kgm²],

Ke_{ph_ph} back emf coefficient phase to phase [V_{rms}/rad/s].

The coefficient Ke_{ph_ph} in the formula above is given in [V_{rms}/rad/s]

To calculate this coefficient from the datasheet, use the following relation:

$$Ke_{ph_ph} [V_{rms}/rad/s] = \frac{Ke_{ph_ph} [V_{rms}/1000rpm]}{\frac{2 * \pi * 1000}{60}}$$

Example:

Motor series NX620EAR

R_{ph_ph} at 25°C = 2.24 Ohm

$J = 98 \cdot 10^{-5} \text{ kgm}^2$

$Ke_{ph_ph} [V_{rms}/1000rpm] = 95.7 [V_{rms}/1000rpm]$

→ $Ke_{ph_ph} [V_{rms}/rad/s] = 95.7 / (2 * \pi * 1000 / 60) = 0.9139 [V_{rms}/rad/s]$

→ $\sigma_{mech} = 0.5 * 2.24 * 98 \cdot 10^{-5} / (0.9139^2) = \mathbf{1.2 \text{ ms}}$



Remarks:

For a DC motor, the mechanical time constant σ_{mech} represents the duration needed to reach 63% of the final speed when applying a voltage step without any resistant torque. However this value makes sense only if the electric time constant σ_{elec} is much smaller than the mechanical time constant σ_{mech} (for the motor NX620EAR taken as illustration, it is not the case because we obtain $\sigma_{mech} < \sigma_{elec}$).

An overall summary of motor time constants is given a little further.

3.2.6.3. Thermal time constant of the copper:

$$\tau_{therm} = Rth_{copper_iron} * Cth_{copper}$$

$$Cth_{copper [J/^{\circ}K]} = Mass_{copper [Kg]} * 389_{[J/kg^{\circ}K]}$$

With:

Rth_{copper_iron} thermal resistance between copper and iron [°K/W]

Cth_{copper} thermal capacity of the copper [J/°K]

Mass_{copper} mass of the copper (winding) [kg]

Hereunder is given an overall summary of motor time constants:

Type	Electric time constant [ms]	Mechanical time constant [ms]	Thermal time constant of copper [s]
NX110E	1.2	1.8	26.1
NX205E	2.6	2.2	38.5
NX210E	2.0	1.5	42.7
NX310E	3.0	1.1	60.2
NX420E	4.6	1.4	71.0
NX430E	5.2	1.1	79.8
NX620E	8.6	1.3	137
NX630E	10.3	1.0	158
NX820E	8.5	2.1	135
NX840E	11.0	1.5	171
NX860E	12.9	1.3	206
NX860V	12.9	1.3	81



3.2.7. Speed ripple

The typical speed ripple for a NX motor with a resolver at 4000rpm is 3% peak to peak. This value is given as indicative data because depending on the settings of the drive (gains of both speed and current regulation loops, presence of filtering or not, load inertia, resistant torque and type of sensor in use), without external load (neither external inertia nor resistant torque).

3.2.8. Cogging torque

The typical cogging for a NX series below is the maximum value peak to peak in N.cm:

Motor	Cogging Maxi [N.cm]
NX110	0.9
NX205	0.8
NX210	1.7
NX310	2.5
NX420	4.4
NX430	5.7
NX620	5.3
NX630	6.8
NX820	9
NX840	16
NX860	20

3.2.9. Rated data according to rated voltage variation

The nominal characteristics and especially the rated speed, maximal speed, rated power, rated torque, depend on the nominal voltage supplying the motor considered as the rated voltage. The rated data mentioned in the data sheet are given for each association of motor and drive. Therefore, if the supply voltage changes, the rated values will also change. As long as the variation of the rated voltage remains limited, for instance $\pm 10\%$ of the nominal value, it is possible to correctly evaluate the new rated values as illustrated below.

Example:

Extract of NX620EAR datasheet

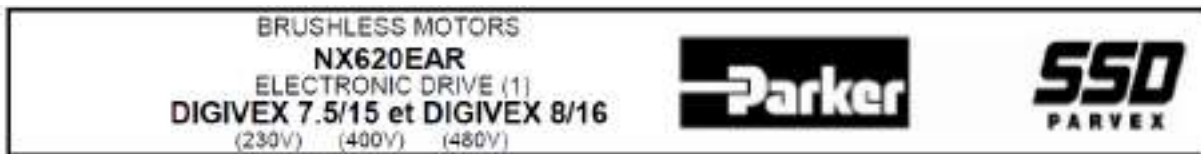

Torque at low speed	M_0	Nm	8		
Permanent current at low speed	I_0	A_{rms}	5.31		
Peak torque	M_p	Nm	26.7		
Current for the peak torque	I_p	A_{rms}	21.2		
Back emf constant at 1000 rpm (25°C)*	K_e	V_{rms}	95.7		
Torque sensitivity	K_t	Nm/A_{rms}	1.51		
Winding resistance (25°C)*	R_b	Ω	2.24		
Winding inductance*	L	mH	19.2		
Rotor inertia	J	$kgm^2 \times 10^{-5}$	98		
Thermal time constant	T_{th}	min	27		
Motor mass	M	kg	7		
Voltage of the mains	UR1 UR2 UR3	V_{rms}	230	400	480
Rated speed	N_{n1} N_{n2} N_{n3}	rpm	2200	3900	4500
Rated torque	M_{n1} M_{n2} M_{n3}	Nm	7.42	6.17	5.57
Rated current	I_{n1} I_{n2} I_{n3}	A_{rms}	4.99	4.25	3.89
Rated power	P_{n1} P_{n2} P_{n3}	W	1710	2520	2620

□ If we suppose that the rated voltage $U_n=400 V_{rms}$ decreases of **10%** ; this means that the new rated voltage becomes $U_{n2}=360 V_{rms}$.

Rated speed:

The former rated speed $N_n=3900$ rpm obtained with a rated voltage $U_n=400 V_{rms}$ and an efficiency of $\eta=92\%$ leads to the new rated speed N_{n2} given as follows:

$$N_{n2} = N_n * \frac{\frac{U_{n2}}{U_n} - 1 + \eta}{\eta}$$

$$N_{n2} = 3900 * \frac{\frac{360}{400} - 1 + 0.92}{0.92} = 3476rpm$$

Maximum speed:

The former maximum speed $N_{\max} = 3900$ rpm obtained with $U_n = 400$ V_{rms} and $N_n = 3900$ rpm leads to the new maximum speed $N_{\max 2}$ given as follows:

$$N_{\max 2} = N_{\max} * \frac{N_{n2}}{N_n} \qquad N_{\max 2} = 3900 * \frac{3476}{3900} = 3476 \text{rpm}$$

N.B.

□ If the rated voltage increases ($U_{n2} > U_n$), the new rated speed N_{n2} and the new maximum speed $N_{\max 2}$ will be greater than the former ones N_n and N_{\max} . Moreover you will have to check that the drive still shows able to deal with the new maximum electric frequency.

	<p><u>Warning:</u> If the main supply decreases, you must reduce the maximum speed accordingly in order not damage the motor. In case of doubt, consult us.</p>
---	---

Rated power:

The former rated power $P_n = 2520$ W obtained with $U_n = 400$ V_{rms} leads to the new rated power P_{n2} given as follows:

$$P_{n2} = P_n * \frac{U_{n2}}{U_n} \qquad P_{n2} = 2520 * \frac{360}{400} = 2268 \text{W}$$

Rated torque:

The former rated torque $M_n = 6.17$ Nm obtained with $U_n = 400$ V_{rms} leads to the new rated torque M_{n2} given as follows:

$$M_{n2} = \frac{P_{n2}}{2 * \pi * N_{n2}} \qquad M_{n2} = \frac{2268}{2 * \pi * 3476} = 6.23 \text{Nm}$$

3.2.10. Voltage withstand characteristics of NX series

The motors fed by converters are subject to higher stresses than in case of sinusoidal power supply. The combination of fast switching inverters with cables will cause overvoltage due to the transmission line effects. The peak voltage is determined by the voltage supply, the length of the cables and the voltage rise time. As an example, with a rise time of 200 ns and a 30 m (100 ft) cable, the voltage at the motor terminals is twice the inverter voltage.

The insulation system of the servomotors NX is designed to withstand high repetitive pulse voltages and largely exceeds the recommendations of the IEC/TS 60034-25 ed 2.0 2007-03-12 for motors without filters up to 500V AC (See figure 1).

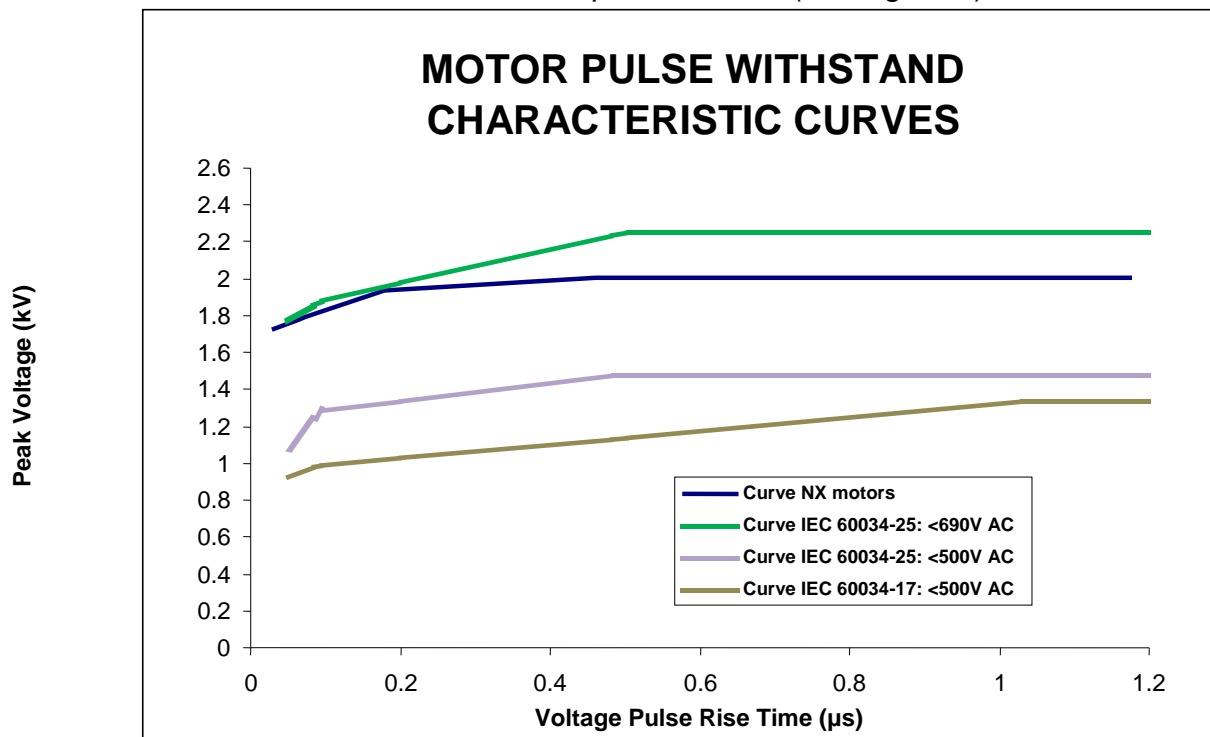

Figure 1: Minimum Voltage withstands characteristics for motors insulations according to IEC standards. At the top are the typical capabilities for the NX motors.

Note: The pulse rise times are defined in accordance with the IEC/TS 60034-17 ed4.0 2006-05-09.

The NX motors can be used with a supply voltage up to 500 V under the following conditions:

- The pulse rise times must be longer than 50 ns.
- The repetitive pulse voltages must not exceed the values given in figure 1, “Curve NX motors” in dark blue.

3.3.3. NX2

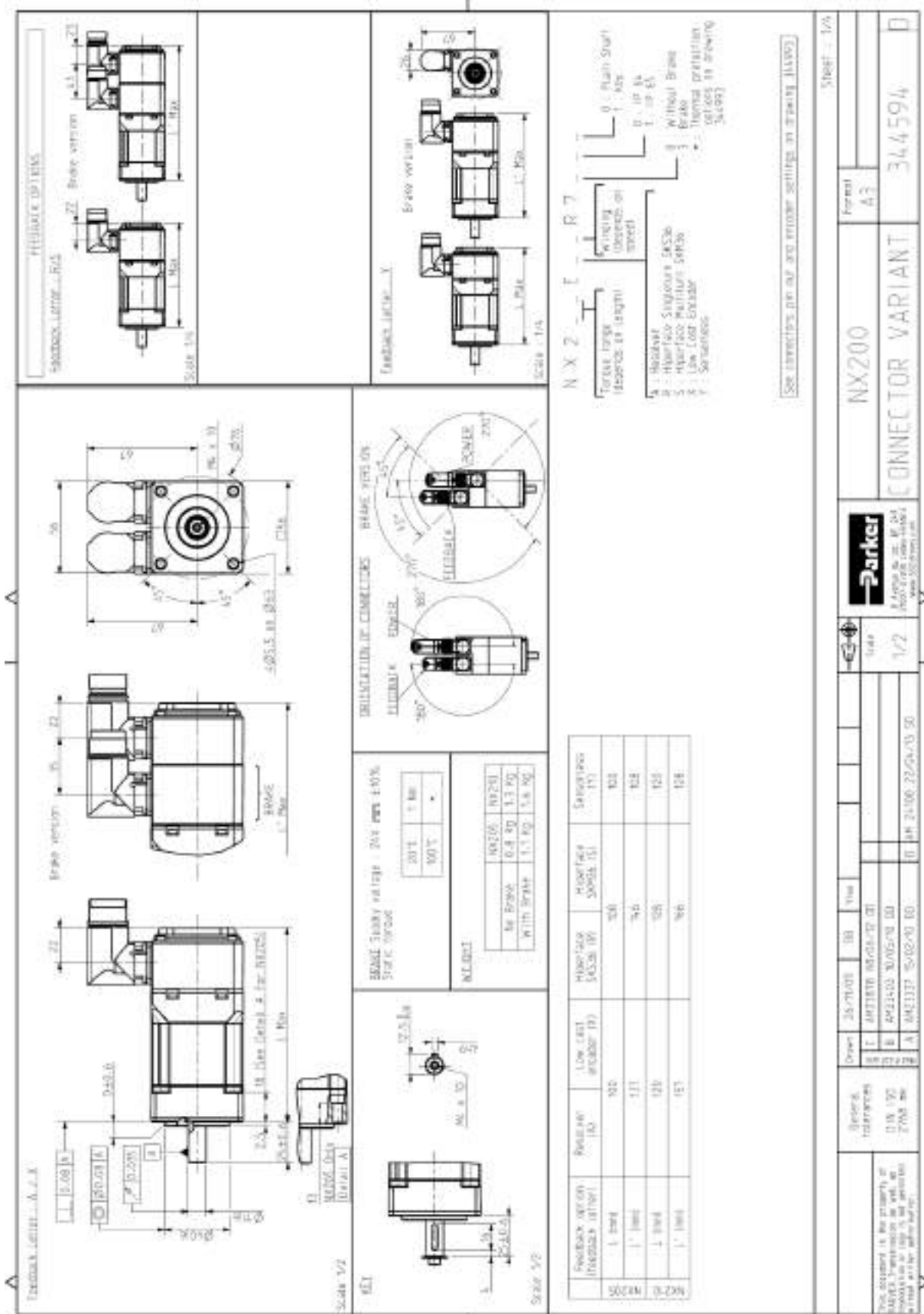

Feedback letter: Y

Scale 1/2

Scale 1/2

BRAKE Supply voltage: 24V \pm 5%
Start torque

-20 °C	1 Nm
100 °C	*

M.U. (Hz)

NX205	NX270
No Brake	0.8 Ns
With Brake	1.1 Ns
	1.9 Ns

N X 2 - E Y - R 0

Torque range depends on length

By using feedback in closed loop

0: No Brake
1: IP 64
2: IP 65
3: Inherent protection against oil leakage
4: With Brake

[See connectors pin list and encoder settings in drawing 344392]

Form A3

NX200

SENSORLESS VARIANT

344594

Sheet: 3/4

Feedback letter: A / A / 3

Scale 1/2

FEEDBACK OPTIONS

Feedback letter: B / 5

Scale 1/4

BRAKE: 24V supply voltage: 24V \pm 0.7%

Stall torque:

20V	1 Nm
10V	•

WEIGHT:

NX205	M270
no Brake	0.9 kg
with Brake	1.3 kg
	1.1 kg
	1.6 kg

KEY

Scale 1/2

Feedback option (feedback letter)	Resolver (A)	Low Cost Encoder (K)	Highgate SAE56 (H)	Superface (SM56) (S)
1' 000	302	302	306	
1' 1000	340	340	346	
1' 2000	322	322	328	
1' 3000	360	360	366	

N X 2 E R 1

Torque range (depends on length)

W milling (depends on speed)

Resolver Superface SAE56 Highgate Multimat SM56 Low Cost Encoder

High Stall Torque

IP 64

IP 65

Without Brake

Brake

Thermal protection (options on drawing 34494)

See with combination out and encoder settings on drawing 344991

3 Ave. de la. St. 344
44111 St. Jean, France
www.parker.com

Scale: 1/2

Stock: 08/11/2018 08:05:47 00

08/11/2018 08:05:47 00

08/11/2018 08:05:47 00

Sheet: A/6

Feedback letter: A / A / 3

Form: A 3

344594

Feedback letter: A / A / 3

CABLE VARIANT

D

3.3.4. NX2 UL version

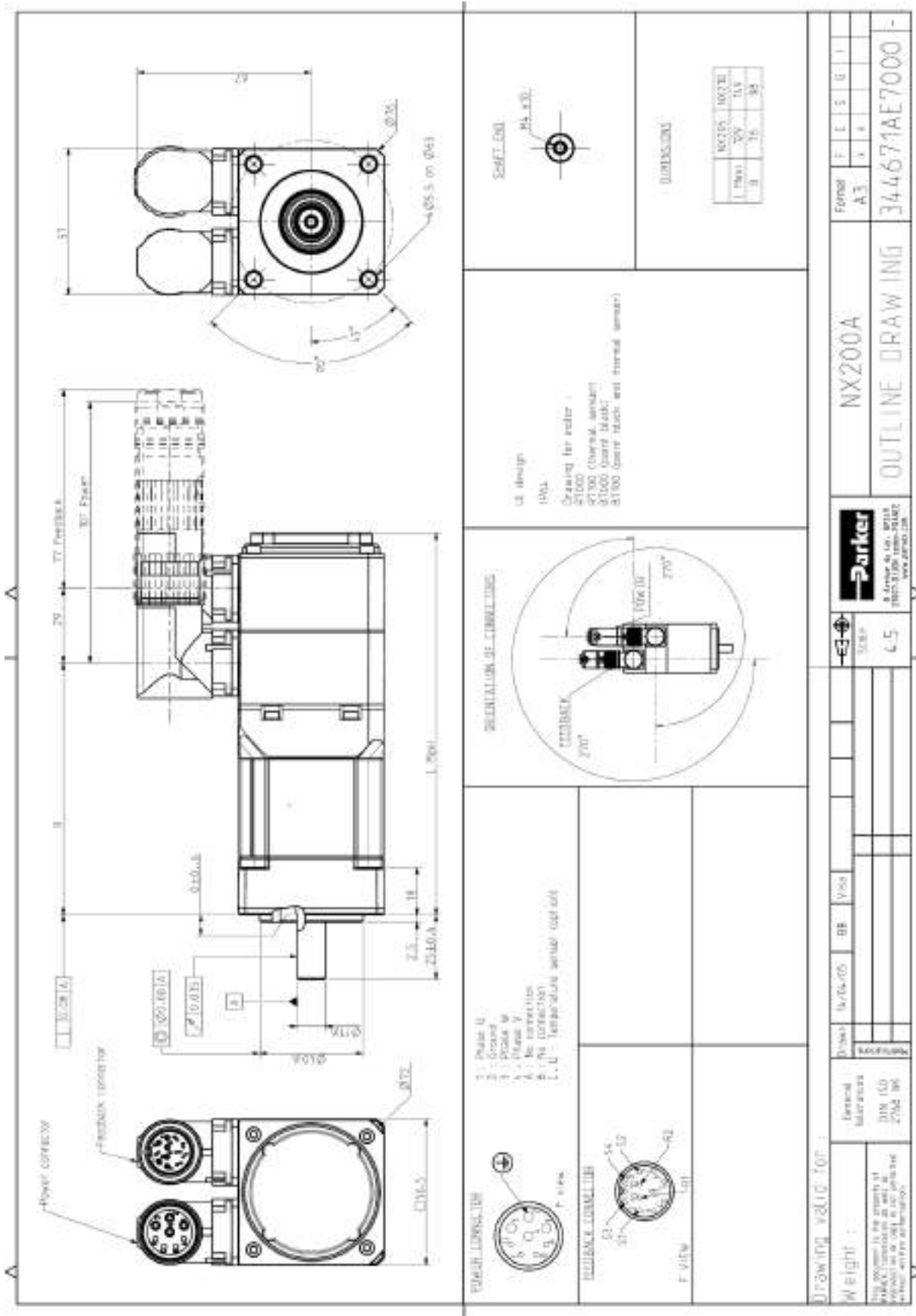

FEEDBACK OPTIONS

Feedback letter: A-Z

Scale 1:2

Feedback letter: A-Z

Scale 1:2

Feedback letter: A-Z

Scale 1:2

Feedback letter: A-Z

Scale 1:2

GEAR: Steady voltage: 24V ± 5%

Stall: 2.1A

Scale 1:2

BRAKE Version

Scale 1:2

BRAKE Version

Scale 1:2

MX310E - R 1

torque range depends on length

Winding (depends on coil)

0: Plain Shaft
1: key
2: 18 14
3: 18 14
4: 18 14

0: Motor Brake
1: Brake
2: Thermal protection
3: Thermal protection coil-ups on drawing
4: 264992
5: 264993

0: Resistor
1: Resistor
2: Resistor
3: Resistor
4: Resistor
5: Resistor
6: Resistor
7: Resistor
8: Resistor
9: Resistor
A: Resistor
B: Resistor
C: Resistor
D: Resistor
E: Resistor
F: Resistor
G: Resistor
H: Resistor
I: Resistor
J: Resistor
K: Resistor
L: Resistor
M: Resistor
N: Resistor
O: Resistor
P: Resistor
Q: Resistor
R: Resistor
S: Resistor
T: Resistor
U: Resistor
V: Resistor
W: Resistor
X: Resistor
Y: Resistor
Z: Resistor

See connections on our and encoder settings on drawing 344593

Sheet: 3/3

Form: F E S G I

A3

CABLE VARIANT

344167

D

Feedback Letter: ACE

Scale: 2:5

Feedback Options

Scale: 1:5

Brake Version

Scale: 1:5

Scale: 2:5

Resolution (ppr)	Low Cost Encoder (C)	Hi-Res Encoder (H)	Endat (E2111) (H)	Endat (E2112) (H)	Hi-Res SPS3 (H)	Hi-Res SPS3 (L)
100		200			200	200
200		256			256	256
400		200			200	200
1000		256			256	256

Supply Voltage

Supply Voltage	Weight	Resolution (ppr)
24V	5.5 kg	5.5 kppr
30V	4.8 kg	4 kppr

Motor

Motor	Weight	Resolution (ppr)
NOV20	5.5 kg	5.5 kppr
NOV30	4.6 kg	4 kppr
NOV40	3.5 kg	3 kppr

Feedback Options

Feedback Option	Resolution (ppr)	Weight
Resistor	100	200
Hi-Res SPS3	200	200
Hi-Res SPS3	256	256
Hi-Res SPS3	400	200
Hi-Res SPS3	1000	256

Encoder Options

Encoder Option	Resolution (ppr)	Weight
Low Cost Encoder	100	200
Hi-Res Encoder	200	200
Hi-Res Encoder	256	256
Hi-Res Encoder	400	200
Hi-Res Encoder	1000	256

Endat Options

Endat Option	Resolution (ppr)	Weight
Endat (E2111)	100	200
Endat (E2111)	200	200
Endat (E2111)	256	256
Endat (E2111)	400	200
Endat (E2111)	1000	256

Hi-Res SPS3 Options

Hi-Res SPS3 Option	Resolution (ppr)	Weight
Hi-Res SPS3 (H)	100	200
Hi-Res SPS3 (H)	200	200
Hi-Res SPS3 (H)	256	256
Hi-Res SPS3 (H)	400	200
Hi-Res SPS3 (H)	1000	256

Other Options

Option	Resolution (ppr)	Weight
Resistor	100	200
Hi-Res SPS3	200	200
Hi-Res SPS3	256	256
Hi-Res SPS3	400	200
Hi-Res SPS3	1000	256

Feedback Options

Scale: 1:5

Brake Version

Scale: 1:5

NX 400

Feedback options on sheet:

- 0: Plain Start
- 1: Resistor
- 2: Hi-Res SPS3
- 3: Endat
- 4: Hi-Res SPS3
- 5: Endat
- 6: Hi-Res SPS3
- 7: Endat
- 8: Hi-Res SPS3
- 9: Endat
- 10: Hi-Res SPS3
- 11: Endat
- 12: Hi-Res SPS3
- 13: Endat
- 14: Hi-Res SPS3
- 15: Endat
- 16: Hi-Res SPS3
- 17: Endat
- 18: Hi-Res SPS3
- 19: Endat
- 20: Hi-Res SPS3

See connection pin out and encoder settings on drawing 344793

Part No: NX400-25

Feedback Letter: ACE

Scale: 2:5

Part No: NX400-25

Feedback Letter: ACE

Scale: 2:5

Part No: NX400-25

Feedback Letter: ACE

Scale: 2:5

Part No: NX400-25

Feedback Letter: ACE

Scale: 2:5

Part No: NX400-25

Feedback Letter: ACE

Scale: 2:5

Part No: NX400-25

Feedback Letter: ACE

Scale: 2:5

Part No: NX400-25

Feedback Letter: ACE

Scale: 2:5

Part No: NX400-25

Feedback Letter: ACE

Scale: 2:5

Part No: NX400-25

Feedback Letter: ACE

Scale: 2:5

Part No: NX400-25

Feedback Letter: ACE

Scale: 2:5

Part No: NX400-25

Feedback Letter: ACE

Scale: 2:5

Part No: NX400-25

Feedback Letter: ACE

Scale: 2:5

Fig. 2.11 *Electrical circuit*

Fig. 2.12 *Brake release*

Fig. 2.13 *Smart Lim*

Supply voltage - 24V nom. ±30%	NK620	NK630
20°C	31 Nm	17 Nm
100°C	8 Nm	5 Nm

Part	Part No.	Part No.
No. brake	6.3.39	8.3.83
With brake	8.89	12.89

Fig. 2.14

Product variant (see table 2.1)	Sensors (*)
L (ref)	81
L (non)	238
L (ref)	210
L (non)	205

Fig. 2.15

NX 600 terminal layout:
 Y - Thermal protection options on braking
 I - Thermal protection options on driving (all speeds)
 R - Thermal protection options on braking (all speeds)
 b - Thermal protection options on braking (all speeds)
 0 - Motor brake

See connectors pin out and exciter settings on drawing 344893

Sheet - 2/23

Format	F	E	S	G	I
A1					

NX600
SENSORLESS VARIANT
 344189
D

3.3.8. NX8

FEEDBACK LETTER - B5, 5, 2, 1, 0

Scale 1/10

Scale 1/20

Scale 1/30

Scale 1/40

Scale 1/50

Scale 1/60

Scale 1/10

Scale 1/20

Scale 1/30

Scale 1/40

Scale 1/50

Scale 1/60

Scale 1/10

Scale 1/20

Scale 1/30

Scale 1/40

Scale 1/50

Scale 1/60

Scale 1/10

Scale 1/20

Scale 1/30

Scale 1/40

Scale 1/50

Scale 1/60

Scale 1/10

Scale 1/20

Scale 1/30

Scale 1/40

Scale 1/50

Scale 1/60

Scale 1/10

Scale 1/20

Scale 1/30

Scale 1/40

Scale 1/50

Scale 1/60

REGIME: Steady voltage - 24V rms ± 0.5%

Static torque:

10°C	36 Nm	26 Nm	35 Nm
50°C	32 Nm	22 Nm	32 Nm

Maximal:

100/20	100/40	100/60	100/80
No Brake	33.5 kg	29.5 kg	27.5 kg
With Brake	35.5 kg	31.5 kg	29.5 kg

FEEDBACK LETTER

N X 8

Winding depends on speed:

- 0 - 1 Pole Start
- 1 - 1 Pole
- 2 - 2 Pole
- 3 - 3 Pole
- 4 - 4 Pole
- 5 - 5 Pole
- 6 - 6 Pole
- 7 - 7 Pole

Feedback options:

- 0 - Without Brake
- 1 - Brake
- 2 - Thermal protection
- 3 - Thermal protection
- 4 - Thermal protection
- 5 - Thermal protection
- 6 - Thermal protection
- 7 - Thermal protection

General

Sheet 1/4

Form A3

CONNECTOR VARIANT 344469

Scale 3:10

3 402431 01/2/15 RB

3.3.9. NX8 water cooled

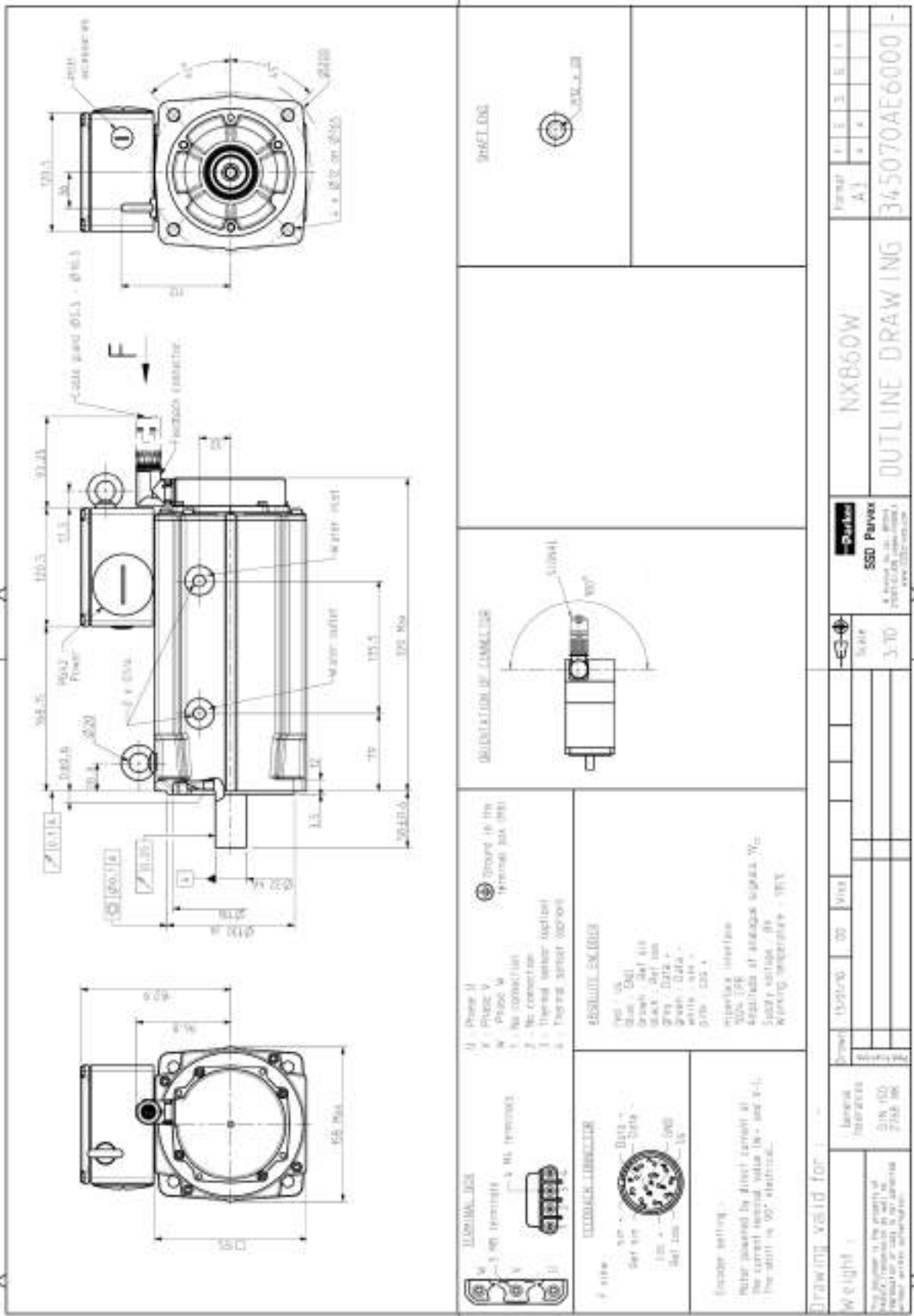

3.4. Motor Mounting

3.4.1. Motor mounting

By flange in any direction

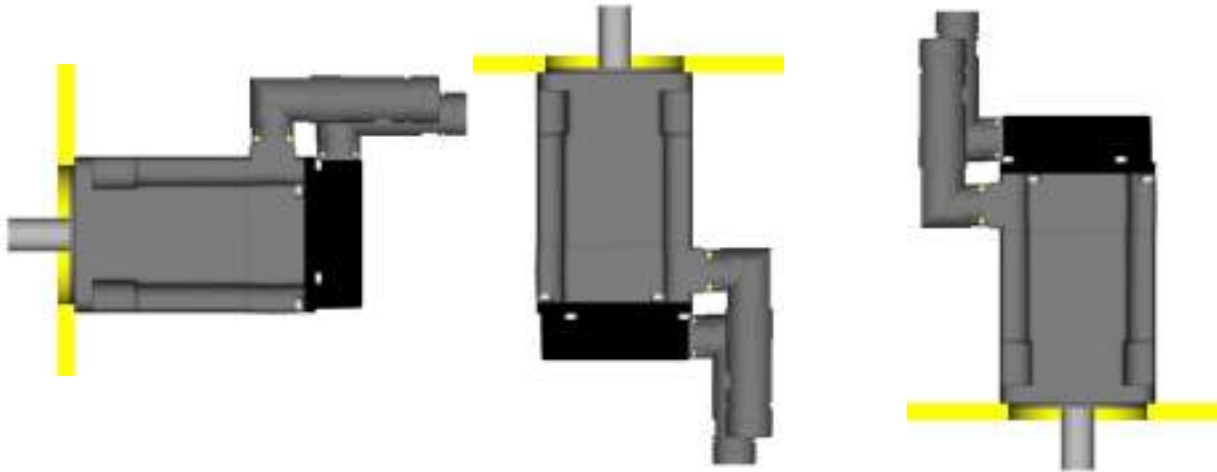

	<p>Warning : For NX8 with fan cooling, the air inlet of the fan has to be at 100mm mini from a wall.</p> <p>100mm</p> <p>Air flow direction</p>
--	--

3.4.2. Frame recommendation

	<p><u>Warning</u> : The user has the entire responsibility to design and prepare the support, the coupling device, shaft line alignment, and shaft line balancing.</p>
---	--

Foundation must be even, sufficiently rigid and shall be dimensioned in order to avoid vibrations due to resonances.

The servomotors need a rigid support, machined and of good quality.

The maximum flatness of the support has to be lower than 0.05mm.

The motor vibration magnitudes in rms value are in accordance with IEC 60034-14 – grade A:

- maximum rms vibration velocity for NX is 1.3mm/s for rigid mounting

	<p><u>Warning</u> : A grade A motor (according to IEC 60034-14) well-balanced, may exhibit large vibrations when installed in-situ arising from various causes, such as unsuitable foundations, reaction of the driven motor, current ripple from the power supply, etc. Vibration may also be caused by driving elements with a natural oscillation frequency very close to the excitation due to the small residual unbalance of the rotating masses of the motor. In such cases, checks should be carried out not only on the machine, but also on each element of the installation. (See ISO 10816-3).</p>
--	--

	<p><u>Warning</u> : A bad setting of the electronic control of the close loop (gain too high, incorrect filtering ...) can occur an instability of the shaft line, vibration or/and breakdown - . Please consult us</p>
---	---



3.5. Shaft Loads

3.5.1. Vibration resistance to shaft end

Frequency domain :10 to 55 Hz according to EN 60068 -2-6
 Vibration resistance to the shaft end :

- radial 3 g
- axial 1 g

3.5.2. Motors life time for horizontal mounting

	<p>The bearing arrangement is made with 2 ball bearings (one on the shaft end + another on the rear). The rear bearing is blocked in axial translation and the front one is free in translation to avoid any stress from the shaft thermal expansion during the running. So, it is important not to block in translation the shaft expansion by any extra bearing or similar device.</p>
	<p><u>Notice:</u> Curves below are valid only for horizontal mounting and a life time L10 of 20 000h at constant speed in accordance with ISO281. <u>Notice:</u> Radial and Axial Loads are not additive</p>

3.5.2.1. NX110

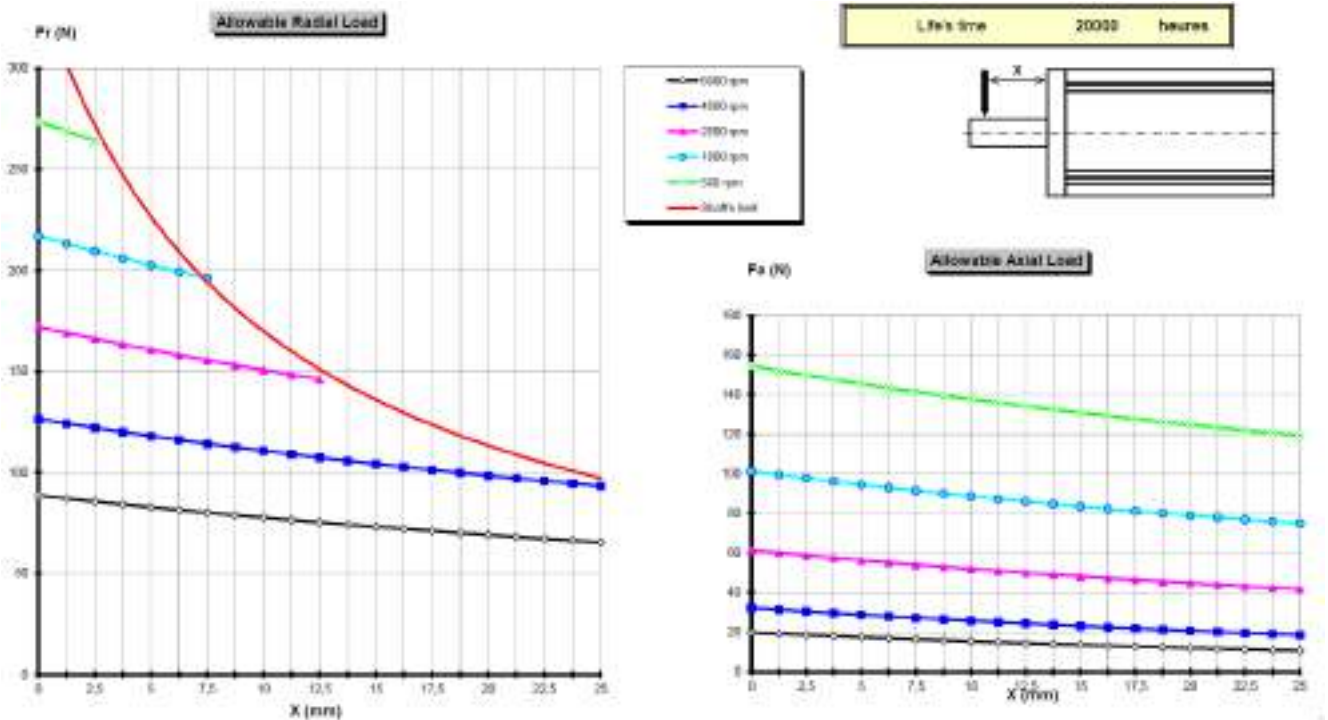

3.5.2.2. NX205

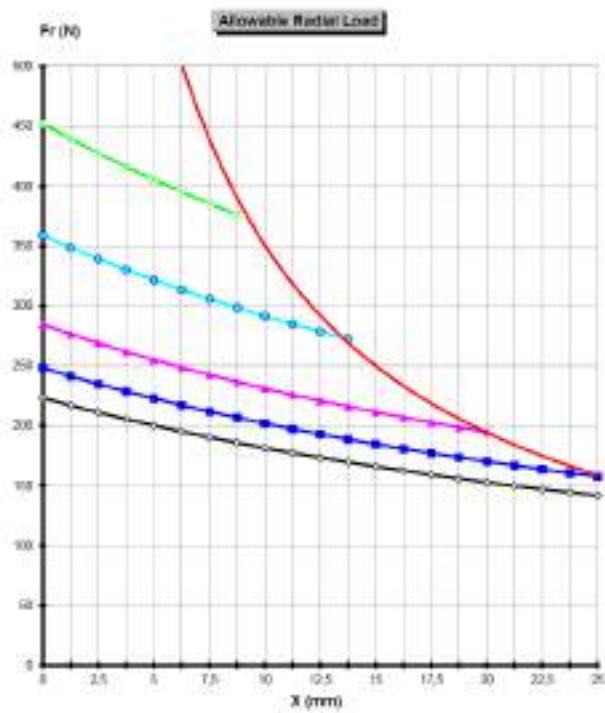

Life's time 20000 heures

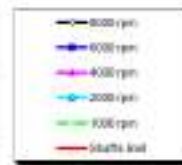
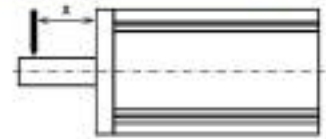

Allowable Axial Load

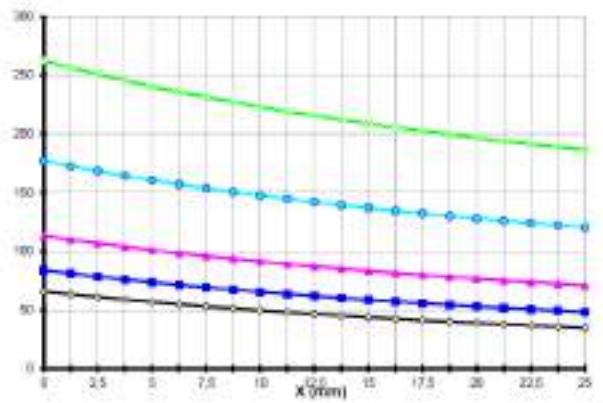

3.5.2.3. NX210

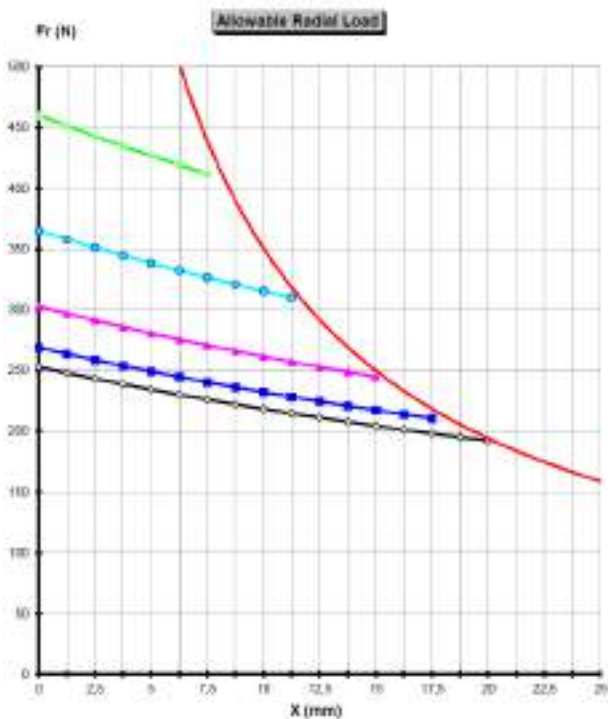

Life's time 20000 heures

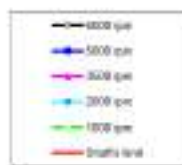
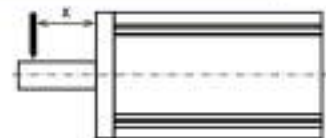

Allowable Axial Load

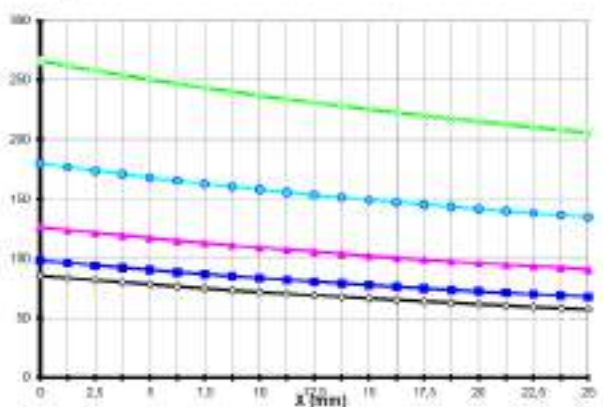

3.5.2.4. NX310

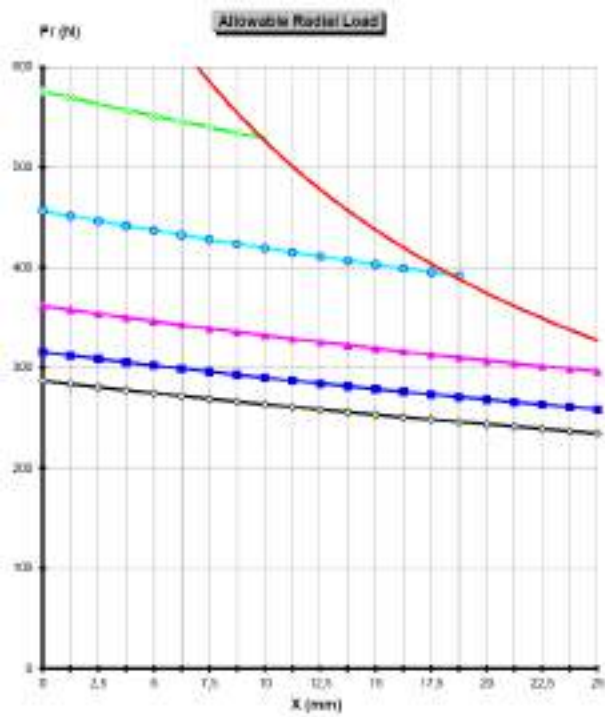

Life's time 20000 heures

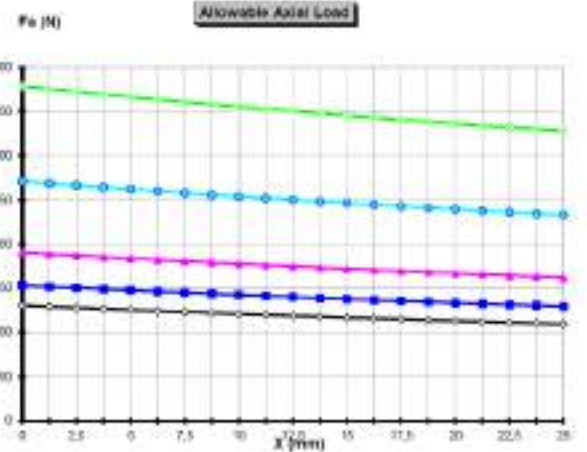
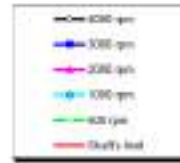
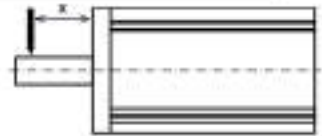

3.5.2.5. NX420

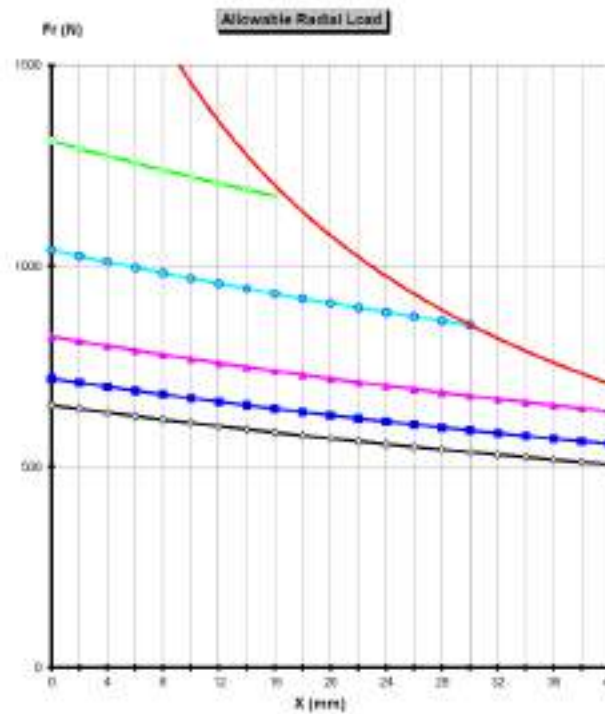

Life's time 20000 heures

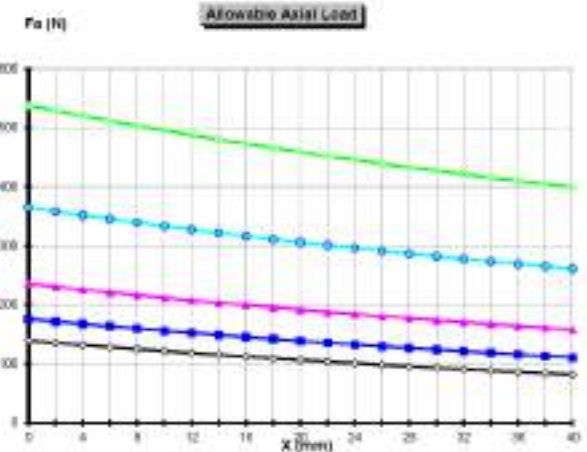
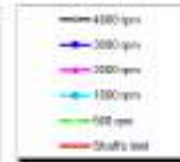
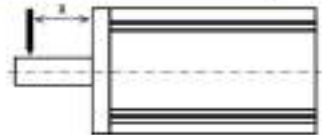

3.5.2.6. NX430

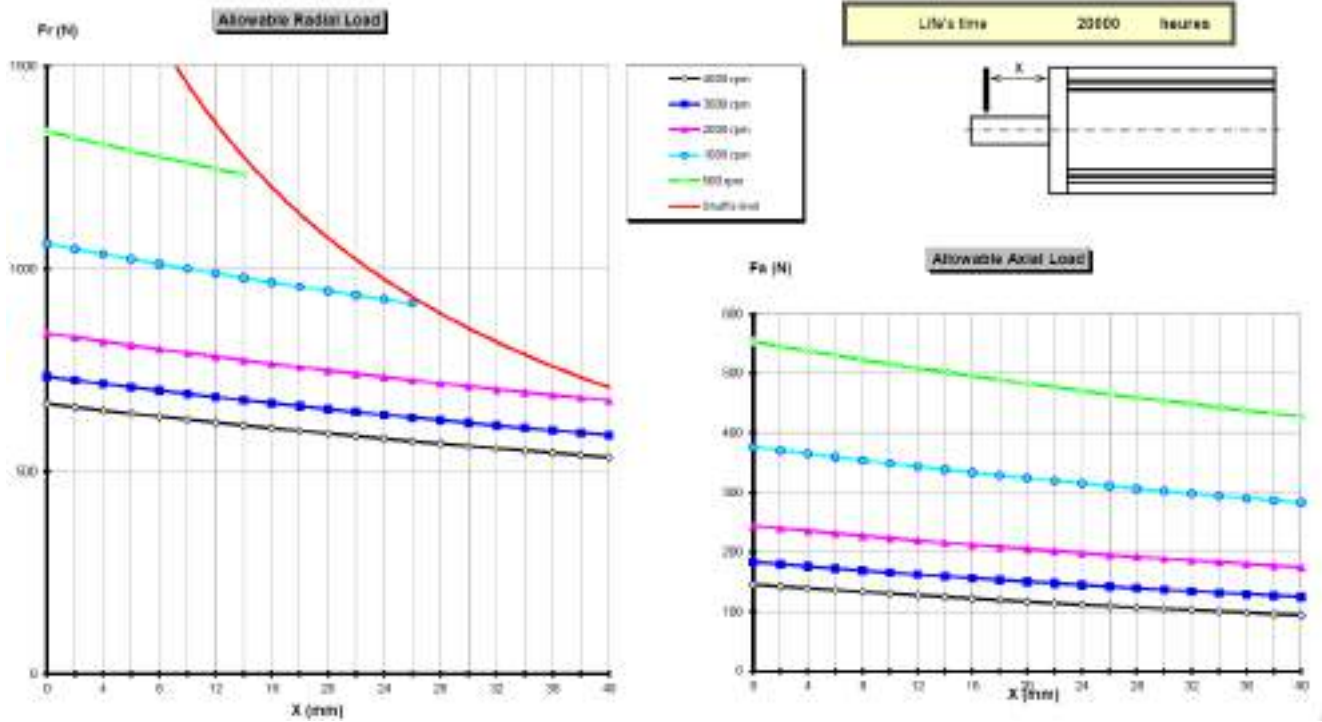

3.5.2.7. NX620

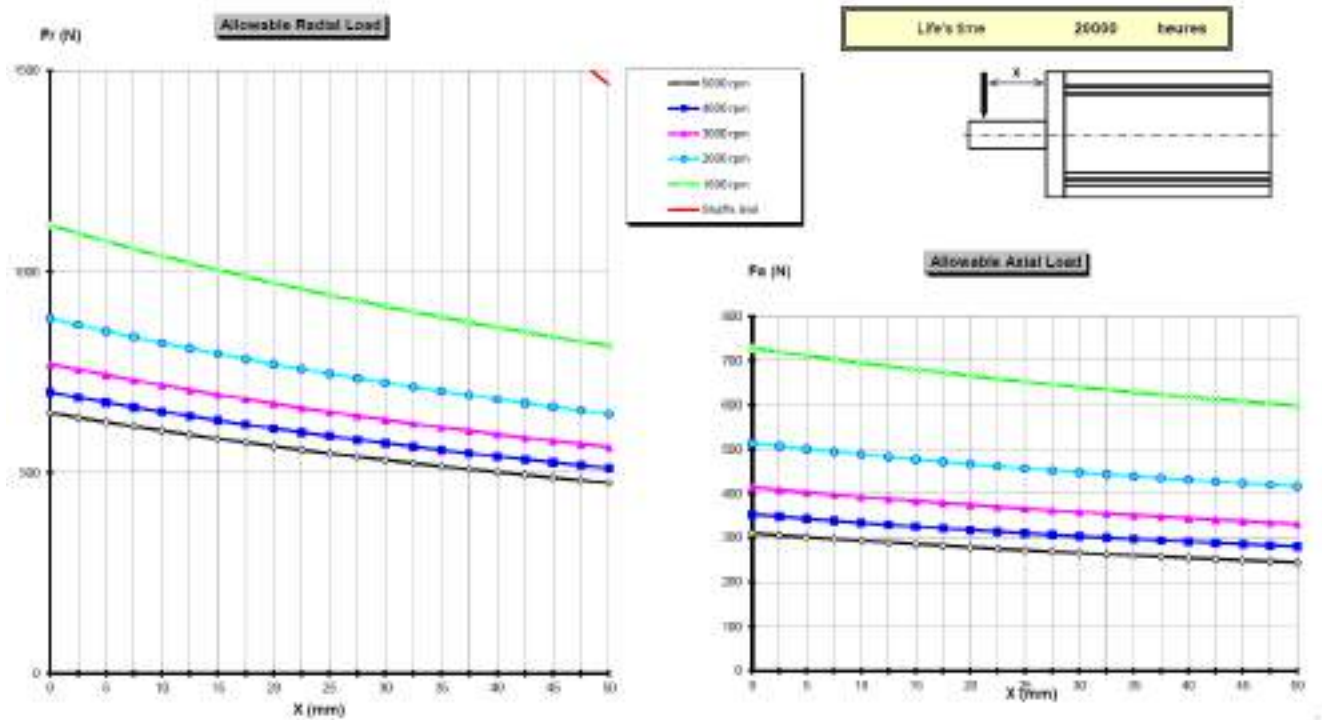

3.5.2.8. NX630

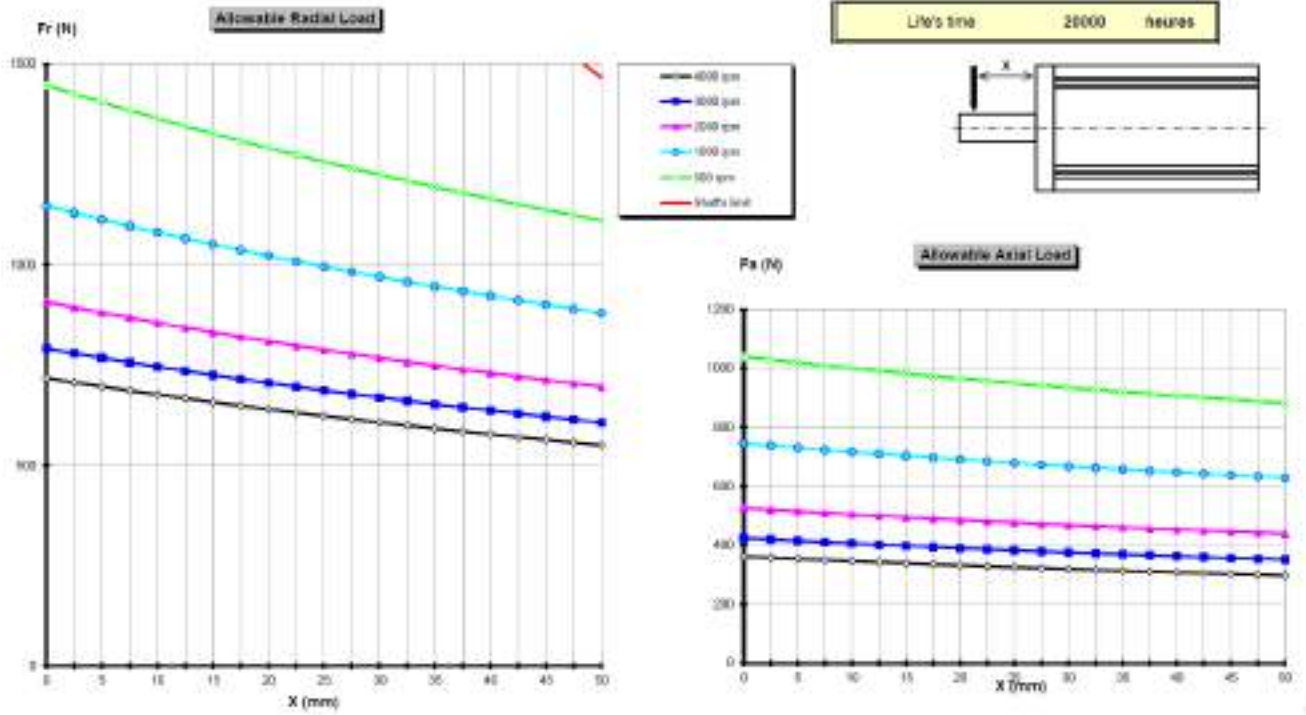

3.5.2.9. NX820

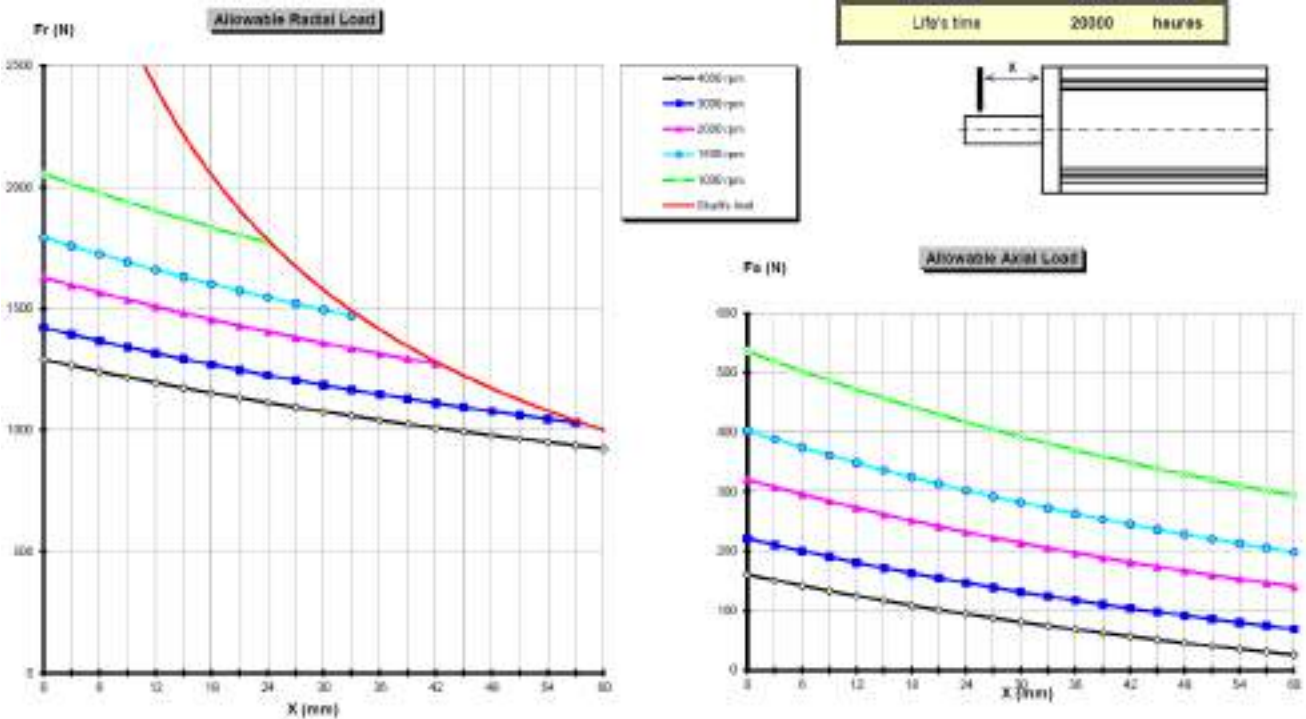

3.5.2.10. NX840

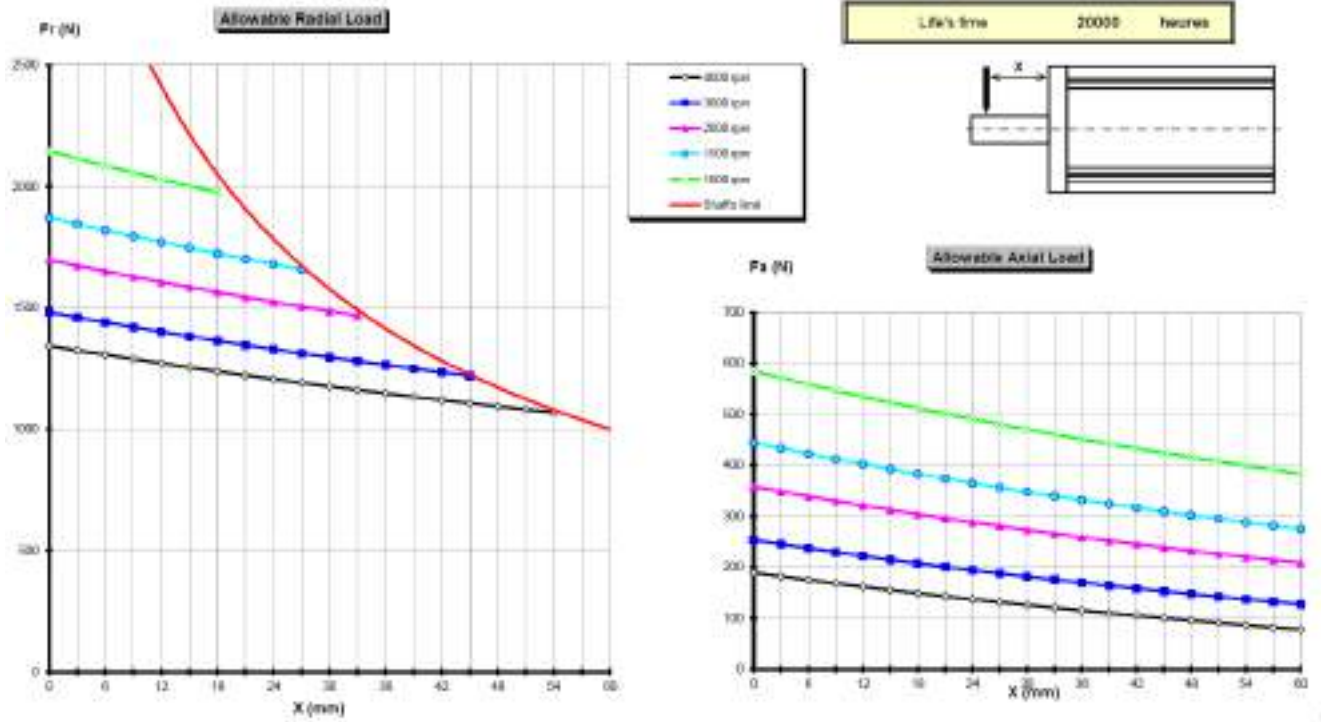

3.5.2.11. NX860

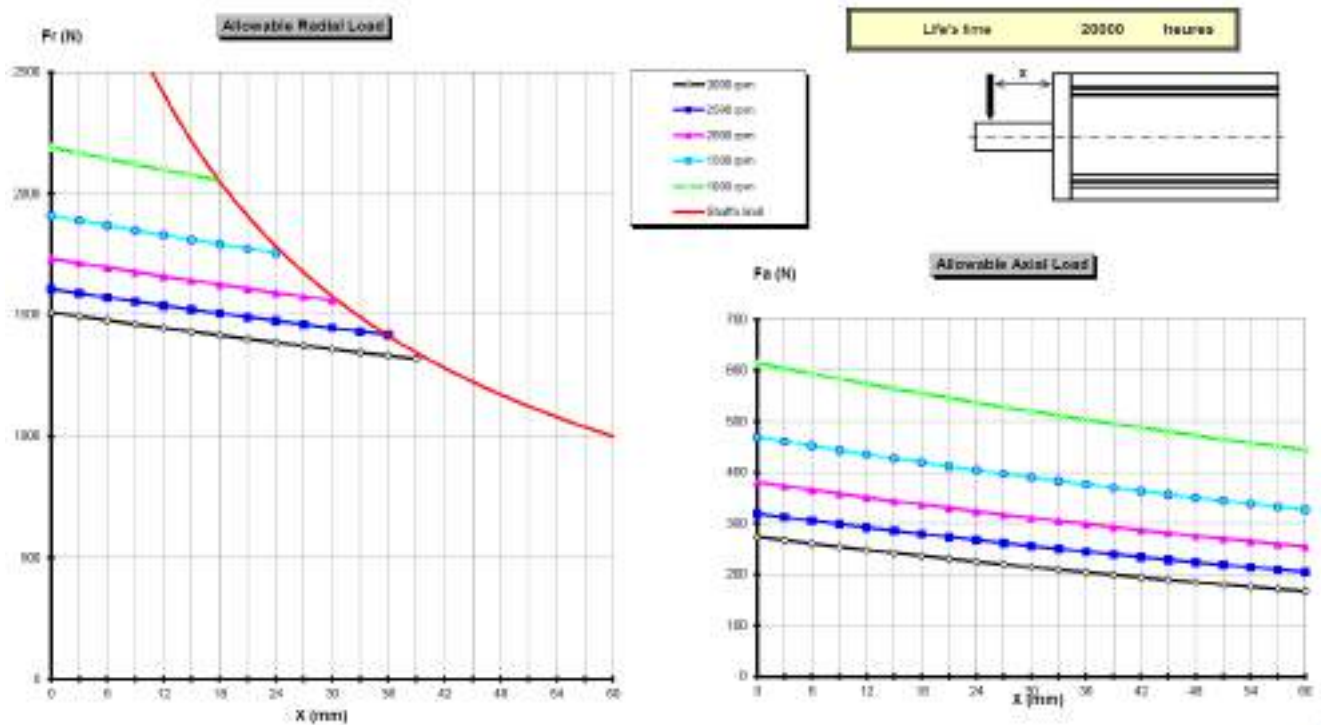





3.6. Cooling

In compliance with the IEC 60034-1 standards:

3.6.1. Natural and fan cooled motor

The ambient air temperature shall not be less than **-15°C** and more than **40°C**.

	<p>It is possible to use the motors in an higher ambient temperature but with an associated derating to the motor performances.</p>
	<p><u>Warning:</u> To reach the motor performances calculated, the motor must be thermally well connected to a aluminium flange with a dimension of 400 mm x 400 mm and with a thickness of 12 mm.</p>
	<p><u>Caution:</u> the ambient air temperature shall not exceed 40°C in the vicinity of the motor flange</p>
	<p><u>Warning:</u> A significant part of the heat produced by the motor is evacuated through the flange.</p> <ul style="list-style-type: none">• if the air is not able to circulate freely around the motor,• if the motor is mounted on a surface that dissipates not well the heating (surface with little dimensions for instance),• if the motor is thermally isolated,• if the motor is mounted on a warm surface (mounted on a gearbox for instance), <p>then the motor has to be used at a torque less than the rated torque.</p>

3.6.2. Fan cooled motor

The ambient air temperature shall not be less than **-15°C** and more than **40°C**.



It is possible to use the motors in an higher ambient temperature but with an associated derating to the motor performances.



Warning: To reach the motor performances calculated, the motor must be thermally well connected to a aluminium flange with a dimension of 400 mm x 400 mm and with a thickness of 12 mm.



Caution: the ambient air temperature shall not exceed 40°C in the vicinity of the motor flange

Air Flow

The air flow is in direction of the shaft end:

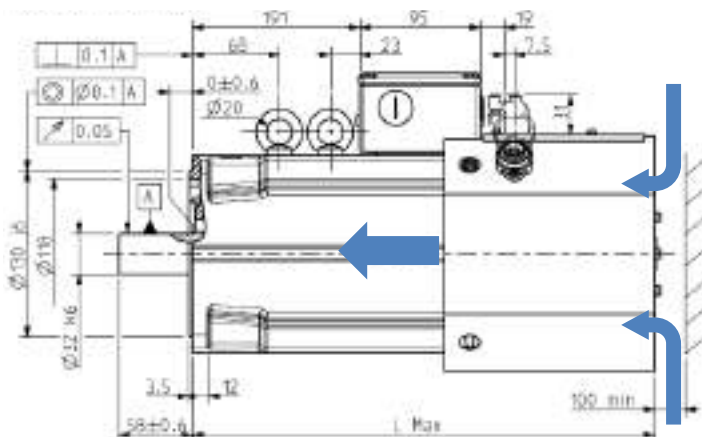







Fan power supply

The power supply of the fan is

- Voltage : 3x 400 VAC
- Power : 40W
- Intensity : 0,11 Amps.

3.6.3. Water cooled motor

	<p><u>Danger:</u> The cooling system has to be operational when the motor is running or energized.</p>
	<p><u>Danger:</u> The Inlet temperature and the water flow have to be monitored to avoid any exceeding values.</p>
	<p><u>Caution:</u> When motor is not running, the cooling system has to be stopped 10 minutes after motor shut down.</p>
	<p><u>Caution:</u> Condensation and risk of rust may occur when the temperature gradient between the air and the water becomes significant. Condensation is also linked to hygrometry rate. To avoid any issue, we recommend: $T_{\text{water}} > T_{\text{air}} - 2^{\circ}\text{C}$. The motor can be used with an ambient temperature between 27°C to 40°C with a high water temperature but with derating. If inlet water temperature becomes higher than 25°C, derating factor must be applied according to §3.1.2 Temperature Derating</p>
	<p><u>Caution:</u> the ambient air temperature shall not exceed 40°C in the vicinity of the motor flange</p>
	<p><u>Danger:</u> If the water flow stops, the motor can be damaged or destroyed causing accidents.</p>

3.6.4. Additives for water as cooling media

Please refer to motor technical data for coolant flow rates.

The water inlet temperature must not exceed **25°C** without torque derating.
The water inlet temperature must not be below **5°C**.

The inner pressure of the cooling liquid must not exceed **5 bars**.

	<p><u>Caution:</u> To avoid the appearance of corrosion of the motor cooling system, the water must have anti-corrosion additive.</p>
---	---

The servomotors are water cooled. Corrosion inhibitors must be added to the water to avoid the corrosion. The complete cooling system must be taken into account to choose the right additive, this includes: the different materials in the cooling circuit, the chiller manufacturer recommendations, the quality of the water...

The right additive solution is under the responsibility of the user. Some additives like TYFOCOR or GLYSANTIN G48 correctly used have demonstrated their ability to prevent corrosion in a closed cooling circuit.

For example: Glysantin G48 recommendations are :

- Water hardness: 0 to 20°dH (0 – 3.6 mmol/l)
- Chloride content: max. 100ppm
- Sulphate content: max. 100ppm

	<p><u>Caution:</u> The water quality is very important and must comply with supplier recommendations. The additive quantity and periodic replacement must respect the same supplier recommendations.</p>
---	--

	<p><u>Caution:</u> The additive choice must take into account the global cooling system (chiller or water exchanger recommendations...).</p>
---	--

	<p>Select carefully the materials of all the cooling system parts (chiller, exchanger, hoses, adapters and fittings) because the difference between material galvanic potential can make corrosion.</p>
---	---



3.6.5. Motor cooling circuit drop pressure

The tab below describes the drop pressure at the water flow rate from the motor data:

Motor type	Drop pressure @ nominal water flow
NX860W	0.3 bar @ 5 l/min

Note : all motors drop pressure are checked before shipping.

3.6.6. Chiller selection

This section describes how to choose the chiller. The chiller is able to evacuate the heat from the motor losses with the water circulation.

The motor losses (= power to evacuate by the chiller) depend on the efficiency and motor power:

$$P_c = \left(\frac{1}{\rho} - 1 \right) \cdot P_n$$

With P_c : Power to evacuate by the chiller (kW)
 P_n : Nominal motor power (kW)
 ρ : motor efficiency at nominal power (%)

Refer to the respective motor data sheet for nominal power, efficiency and water flow. Chiller pump must provide water flow through motor and pipe pressure drop. Inlet temperature must be inferior to **25°C**.

Example

Motor : NX860W

For a torque of 80 N.m @ 2500 rpm, the efficiency is 92%.

Water flow = 5 l/min

$$P_n = 80 \times 2500 \times \pi / 30$$

$$P_n = 20.9 \text{ kW}$$

$$P_c = \left(\frac{1}{0.92} - 1 \right) \cdot 20.9 = \mathbf{1.8 \text{ kW}}$$

So, the chiller must evacuate 1.8 kW and has a water flow of 5 l/min for this point of running.

3.6.7. Flow derating according to glycol concentration

	Glycol concentration [%]					
	0	10	20	30	40	50
5	5.1	5.3	5.6	5.9	6.2	
10	10.2	10.6	11.1	11.8	12.4	
15	15.3	15.9	16.7	17.6	18.7	
20	20.4	21.2	22.2	23.5	24.9	
25	25.5	26.5	27.8	29.4	31.1	
30	30.6	31.8	33.4	35.3	37.3	
35	35.7	37.1	38.9	41.1	43.6	
40	40.8	42.4	44.5	47.0	49.8	
45	45.9	47.7	50.0	52.9	56.0	
50	51.0	53.0	55.6	58.8	62.2	
55	56.1	58.3	61.2	64.7	68.4	
60	61.2	63.5	66.7	70.5	74.7	
65	66.4	68.8	72.3	76.4	80.9	
70	71.5	74.1	77.8	82.3	87.1	
75	76.6	79.4	83.4	88.2	93.3	
80	81.7	84.7	89.0	94.1	99.5	
85	86.8	90.0	94.5	99.9	105.8	
90	91.9	95.3	100.1	105.8	112.0	
95	97.0	100.6	105.6	111.7	118.2	
100	102.1	105.9	111.2	117.6	124.4	
110	112.3	116.5	122.3	129.3	136.9	
120	122.5	127.1	133.4	141.1	149.3	
130	132.7	137.7	144.6	152.8	161.8	
140	142.9	148.3	155.7	164.6	174.2	
150	153.1	158.9	166.8	176.3	186.6	
160	163.3	169.5	177.9	188.1	199.1	
170	173.5	180.1	189.0	199.9	211.5	
180	183.7	190.6	200.2	211.6	224.0	
190	194.0	201.2	211.3	223.4	236.4	
200	204.2	211.8	222.4	235.1	248.9	

Use of the table above - Example

If the motor needs **25 l/min** with **0%** glycol,

If application needs **20%** glycol, the water flow must be **26.5 l/min**,

If application needs **40%** glycol, the water flow must be **29.4 l/min**.



Main formulas

$$Flow_rate = \frac{Power_dissipation * 60}{\Delta\theta * C_p}$$

With: *Flow rate* [l/min]
Power_dissipation [W]
 $\Delta\theta$ Gradient inlet-outlet [°C]
C_p thermal specific capacity of the water as coolant [J/kg°K]
(**C_p** depends on the % glycol concentration please see below)

Thermal specific capacity C_p according to % glycol concentration and temperature

We have considered an average temperature of the coolant of 30°C.

Glycol concentration [%]	Average temperature of the water as coolant [°C]	Thermal specific capacity of the water C_p [J/kg°K]
0	30	4176
30	30	3755
40	30	3551
50	30	3354

3.6.8. Water cooling diagram

	<p><u>Recommendation:</u> The use of a filter allows to reduce the presence of impurities or chips in the water circuit in order to prevent its obstruction. We recommend 0.1mm filter.</p>
--	---

This section shows typical water cooling diagram :

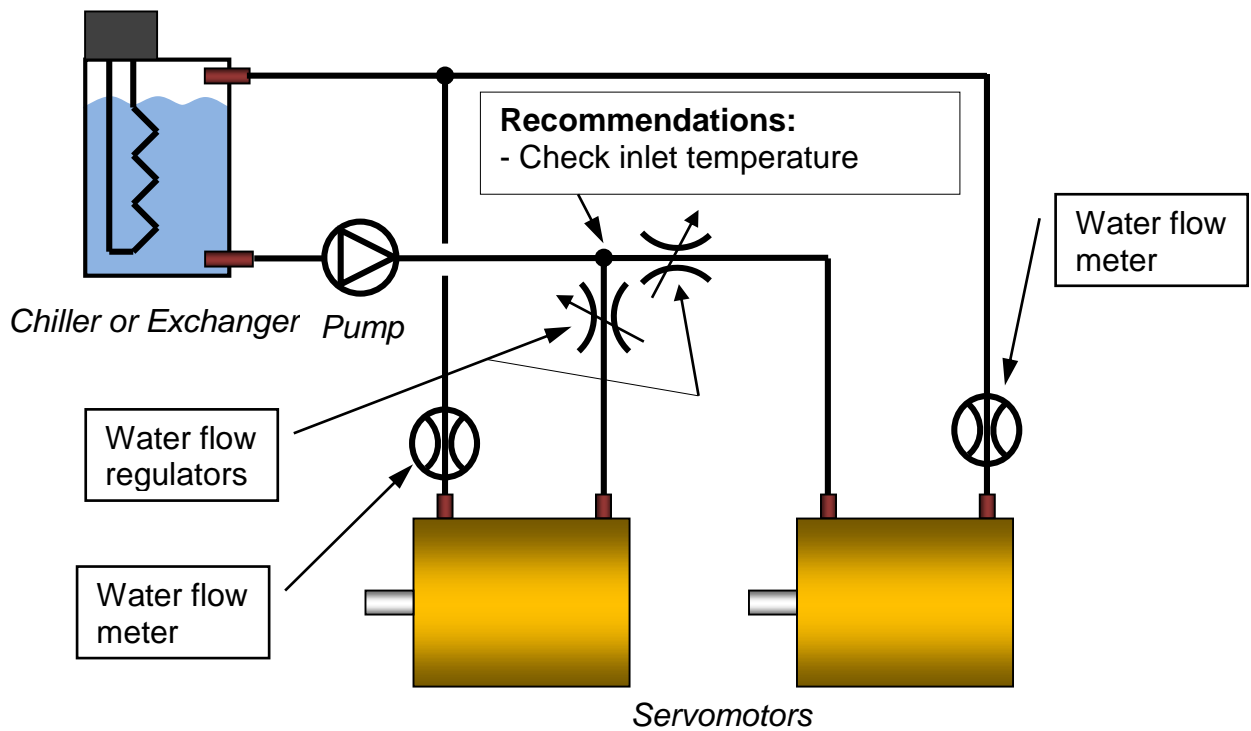
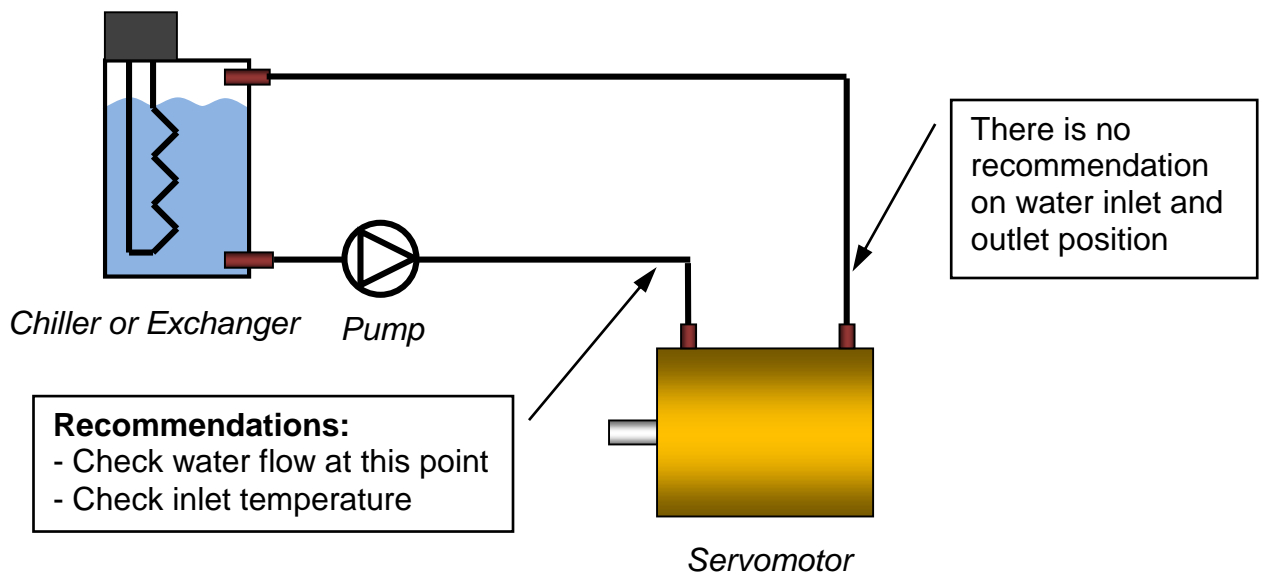

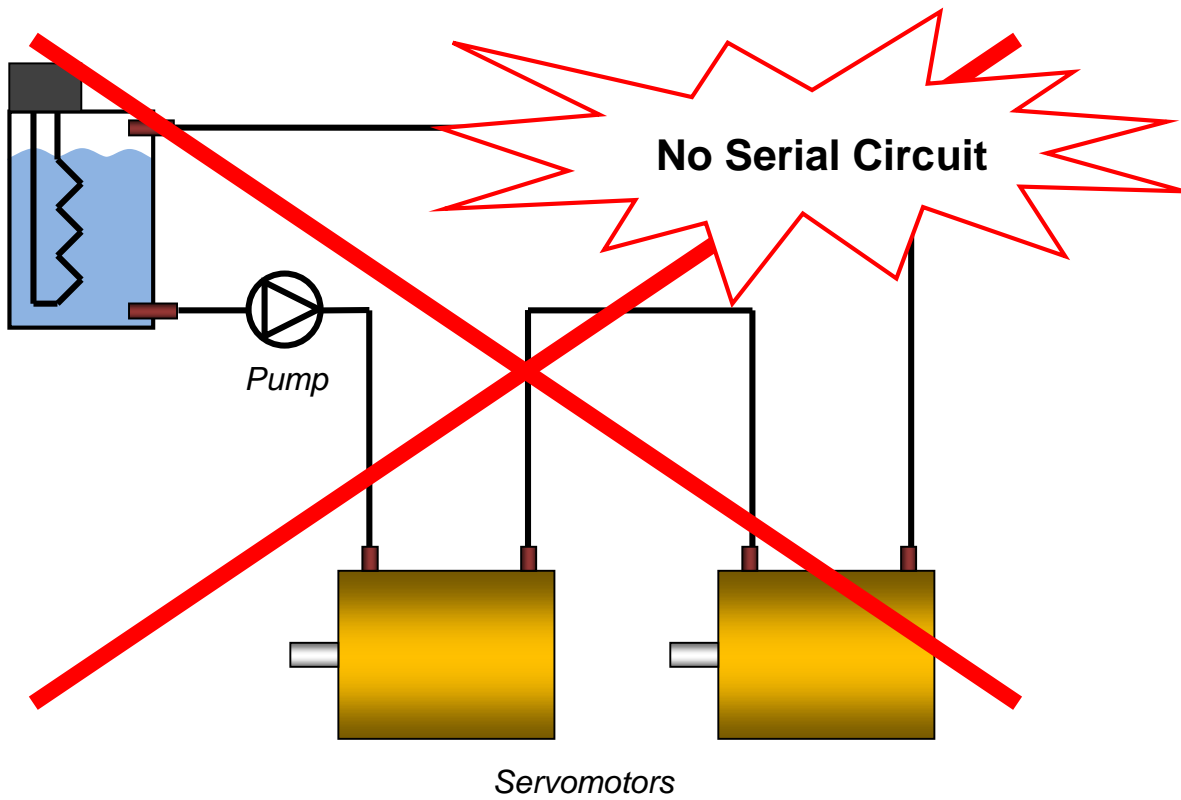
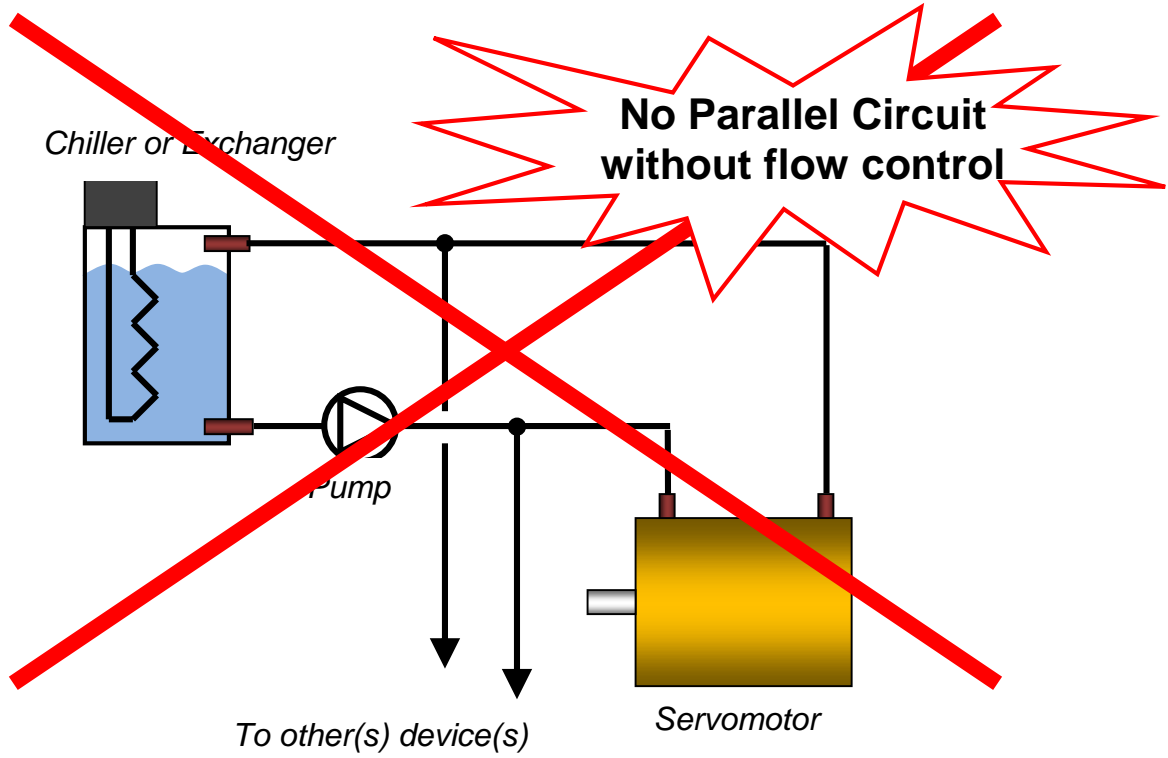

3.7. Thermal Protection

Different protections against thermal overloading of the motor are proposed as an option: Thermoswitch, PTC thermistors or KTY temperature built into the stator winding. No thermal protection are available for the NX1 motor

The thermal sensors, due to their thermal inertia, are unable to follow very fast winding temperature variations. They achieve their thermal steady state after a few minutes.

	<p><u>Warning:</u> To protect correctly the motor against very fast overload, please refer to 3.1.6. Peak current limitations</p>
--	---

3.7.1. Alarm tripping with PTC thermistors :

One thermal probe (PTC thermistors) fitted in the NX servomotor winding trip the electronic system at $150^{\circ} \pm 5^{\circ} \text{C}$ for class F version. When the rated tripping temperature is reached, the PTC thermistor undergoes a step change in resistance. This means that a limit can be easily and reliably detected by the drive.

The graph and tab below shows PTC sensor resistance as a function of temperature (T_N is nominal temperature)

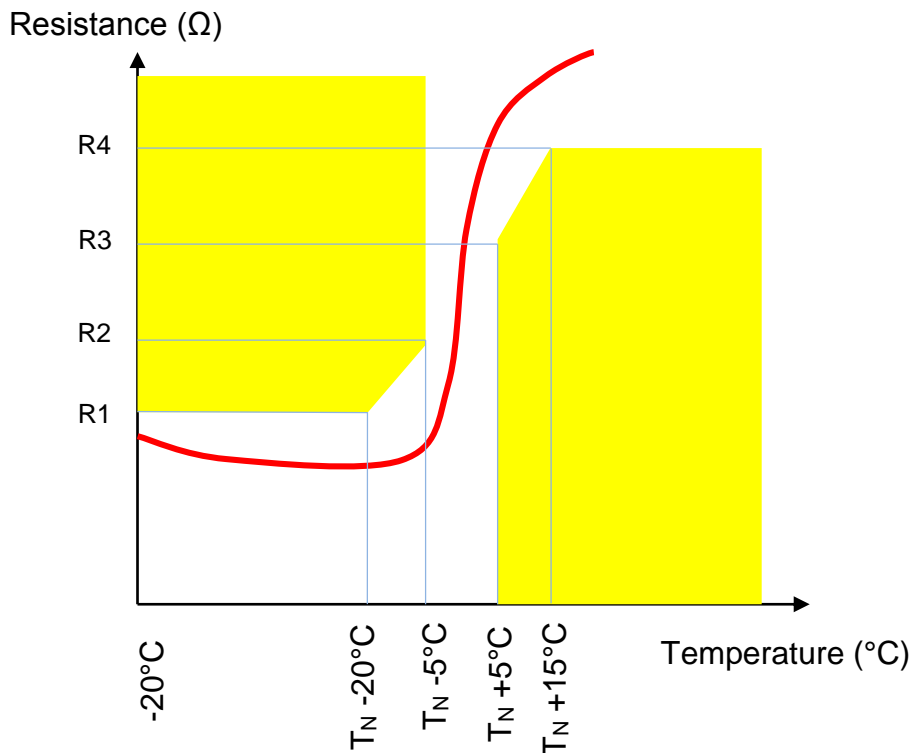

Temperature	Resistance value for NX2, NX6 and NX8	Resistance value for NX3 and NX4
-20°C up to $T_N - 20^{\circ}\text{C}$	$R1 \leq 500\Omega$	$R1 \leq 750\Omega$
$T_N - 5^{\circ}\text{C}$	$R2 \leq 1100\Omega$	$R2 \leq 1650\Omega$
$T_N + 5^{\circ}\text{C}$	$R3 \geq 2660\Omega$	$R3 \geq 3990\Omega$
$T_N + 15^{\circ}\text{C}$	$R4 \geq 8000\Omega$	$R4 \geq 12000\Omega$

3.7.2. Temperature measurement with KTY sensors:

Motor temperature can also be continuously monitored by the drive using a KTY 84-130 thermal sensor built in to the stator winding. KTY sensors are semiconductor sensors that change their resistance according to an approximately linear characteristic. The required temperature limits for alarm and tripping can be set in the drive.

The graph below shows KTY sensor resistance vs temperature, for a measuring current of 2 mA:

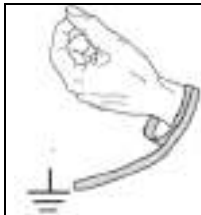
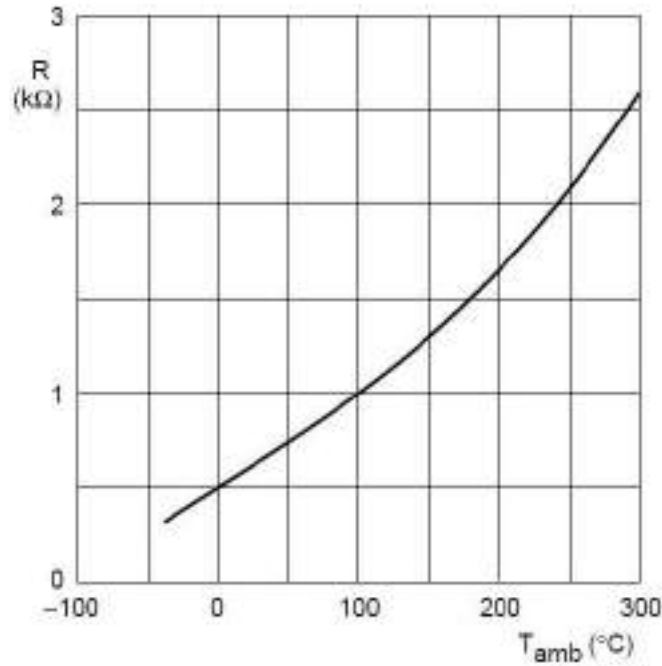

Warning: KTY sensor is sensitive to electrostatic discharge. So, always wear an antistatic wrist strap during KTY handling.



Warning: KTY sensor is polarized. Do not invert the wires.



Warning: KTY sensor is sensitive. Do not check it with an Ohmmeter or any measuring or testing device.

3.8. Power Electrical Connections

3.8.1. Wires sizes

	<p>In every country, you must respect all the local electrical installation regulations and standards.</p>
---	--

Not limiting example in France: NFC 15-100 or IEC 60364 as well in Europe.

	<p>Cable selection depends on the cable construction, so refer to the cable technical documentation to choose wire sizes</p>
---	--

	<p>Some drives have cable limitations or recommendations; please refer to the drive technical documentation for any further information.</p>
--	--

Cable selection

	<p>At standstill, the current must be limited at 80% of the low speed current I_0 and cable has to support peak current for a long period. So, if the motor works at standstill, the current to select wire size is $\sqrt{2} \times 0.8 I_0 \cong 1,13 \times I_0$.</p>
---	--

Sizes for H07 RN-F cable, for a 3 cores in a cable tray at 30°C max

Section [mm ²]	I _{max} [A _{rms}]
1.5	17
2.5	23
4	31
6	42
10	55
16	74
25	97
35	120
50	146
70	185
95	224
120	260
150	299
185	341
240	401
300	461



Example of sizes for H07 RN-F cable :

Conditions of use:

Case of 3 conductors type H07 RN-F: **60°C maximum**

Ambient temperature: 30°C

Cable runs on dedicated cables ways

Current limited to 80%*I₀ at low speed or at motor stall.

Example:

I₀=100 Arms

Permanent current at standstill : 80 Arms

Max permanent current in the cable = 113 Arms

Cable section selection = 35mm² for a 3 cores in a cable tray at 30°C max.

You also have to respect the Drive commissioning manual and the cables current densities or voltage specifications

3.8.2. Conversion Awg/kcmil/mm²:

Awg	kcmil	mm ²
	500	253
	400	203
	350	177
	300	152
	250	127
0000 (4/0)	212	107
000 (3/0)	168	85
00 (2/0)	133	67.4
0 (1/0)	106	53.5
1	83.7	42.4
2	66.4	33.6
3	52.6	26.7
4	41.7	21.2
5	33.1	16.8
6	26.3	13.3
7	20.8	10.5
8	16.5	8.37
9	13.1	6.63
10	10.4	5.26
11	8.23	4.17
12	6.53	3.31
14	4.10	2.08
16	2.58	1.31
18	1.62	0.82
20	1.03	0.52
22	0.63	0.32
24	0.39	0.20
26	0.26	0.13

3.8.3. Motor cable length

For motors windings which present low inductance values or low resistance values, the own cable inductance, respectively own resistance, in case of large cable length can greatly reduce the maximum speed of the motor. Please contact PARKER for further information.



Caution: It might be necessary to fit a filter at the servo-drive output if the length of the cable exceeds 25 m. Consult us.

3.8.4. Mains supply connection diagrams

Temperature Sensor on Power Connector

0 : None	3 : Brake
1 : PTC	4 : Brake + PTC
2 : Thermistor	5 : Brake + Thermistor
6 : RTD	7 : Brake + RTD

Temperature Sensor on Signal Connector

4 : PTC	8 : Brake + PTC
5 : Thermistor	9 : Brake + Thermistor
6 : RTD	7 : Brake + RTD

POWER CABLE	SIGNAL CABLE	FEEDBACK LETTERS	CABLE VARIANT
<p>Motor Size : NX1/2 Cable diameter : Ø9.5 Shielded pairs E0629...A...0.25.mil Black : phase U white : phase V red : phase W yellow/green : ground ACCESSORIES...A...2...0.25.mil Yellow : No connection Orange : No connection Green : Brake Green Red : Brake</p> <p>if the option is required</p>	<p>Motor Size : NX1/2 Cable diameter : Ø9.5 Shielded pairs E0629...A...0.25.mil Black : phase U white : phase V red : phase W yellow/green : ground ACCESSORIES...A...2...0.25.mil Yellow : No connection Orange : No connection Green : Brake Green Red : Brake</p> <p>if the option is required</p>	<p>Feedback Letter : A Motor powered by direct current at the correct nominal value (V_N) value in encoder memory is 200 V_N - 800Vrms.</p>	<p>Motor Size : NX1/2 Cable diameter : Ø9.5 Shielded pairs E0629...A...0.25.mil Black : phase U white : phase V red : phase W yellow/green : ground ACCESSORIES...A...2...0.25.mil Yellow : No connection Orange : No connection Green : Brake Green Red : Brake</p> <p>if the option is required</p>
<p>Motor Size : NX1/2 Cable diameter : Ø9.5 Shielded pairs E0629...A...0.25.mil Black : phase U white : phase V red : phase W yellow/green : ground ACCESSORIES...A...2...0.25.mil Yellow : No connection Orange : No connection Green : Brake Green Red : Brake</p> <p>if the option is required</p>	<p>Motor Size : NX1/2 Cable diameter : Ø9.5 Shielded pairs E0629...A...0.25.mil Black : phase U white : phase V red : phase W yellow/green : ground ACCESSORIES...A...2...0.25.mil Yellow : No connection Orange : No connection Green : Brake Green Red : Brake</p> <p>if the option is required</p>	<p>Feedback Letter : T/U Motor powered by direct current at the correct nominal value (V_N) value in encoder memory is 200 V_N - 800Vrms.</p>	<p>Motor Size : NX1/2 Cable diameter : Ø9.5 Shielded pairs E0629...A...0.25.mil Black : phase U white : phase V red : phase W yellow/green : ground ACCESSORIES...A...2...0.25.mil Yellow : No connection Orange : No connection Green : Brake Green Red : Brake</p> <p>if the option is required</p>
<p>Motor Size : NX1/2 Cable diameter : Ø9.5 Shielded pairs E0629...A...0.25.mil Black : phase U white : phase V red : phase W yellow/green : ground ACCESSORIES...A...2...0.25.mil Yellow : No connection Orange : No connection Green : Brake Green Red : Brake</p> <p>if the option is required</p>	<p>Motor Size : NX1/2 Cable diameter : Ø9.5 Shielded pairs E0629...A...0.25.mil Black : phase U white : phase V red : phase W yellow/green : ground ACCESSORIES...A...2...0.25.mil Yellow : No connection Orange : No connection Green : Brake Green Red : Brake</p> <p>if the option is required</p>	<p>Feedback Letter : R/S Motor powered by direct current at the correct nominal value (V_N) value in encoder memory is 200 V_N - 800Vrms.</p>	<p>Motor Size : NX1/2 Cable diameter : Ø9.5 Shielded pairs E0629...A...0.25.mil Black : phase U white : phase V red : phase W yellow/green : ground ACCESSORIES...A...2...0.25.mil Yellow : No connection Orange : No connection Green : Brake Green Red : Brake</p> <p>if the option is required</p>
<p>Motor Size : NX1/2 Cable diameter : Ø9.5 Shielded pairs E0629...A...0.25.mil Black : phase U white : phase V red : phase W yellow/green : ground ACCESSORIES...A...2...0.25.mil Yellow : No connection Orange : No connection Green : Brake Green Red : Brake</p> <p>if the option is required</p>	<p>Motor Size : NX1/2 Cable diameter : Ø9.5 Shielded pairs E0629...A...0.25.mil Black : phase U white : phase V red : phase W yellow/green : ground ACCESSORIES...A...2...0.25.mil Yellow : No connection Orange : No connection Green : Brake Green Red : Brake</p> <p>if the option is required</p>	<p>Feedback Letter : V/W Motor powered by direct current at the correct nominal value (V_N) value in encoder memory is 420 V_N - 800Vrms.</p>	<p>Motor Size : NX1/2 Cable diameter : Ø9.5 Shielded pairs E0629...A...0.25.mil Black : phase U white : phase V red : phase W yellow/green : ground ACCESSORIES...A...2...0.25.mil Yellow : No connection Orange : No connection Green : Brake Green Red : Brake</p> <p>if the option is required</p>
<p>Motor Size : NX1/2 Cable diameter : Ø9.5 Shielded pairs E0629...A...0.25.mil Black : phase U white : phase V red : phase W yellow/green : ground ACCESSORIES...A...2...0.25.mil Yellow : No connection Orange : No connection Green : Brake Green Red : Brake</p> <p>if the option is required</p>	<p>Motor Size : NX1/2 Cable diameter : Ø9.5 Shielded pairs E0629...A...0.25.mil Black : phase U white : phase V red : phase W yellow/green : ground ACCESSORIES...A...2...0.25.mil Yellow : No connection Orange : No connection Green : Brake Green Red : Brake</p> <p>if the option is required</p>	<p>Feedback Letter : X Motor powered by direct current at the correct nominal value (V_N) value in encoder memory is 420 V_N - 800Vrms.</p>	<p>Motor Size : NX1/2 Cable diameter : Ø9.5 Shielded pairs E0629...A...0.25.mil Black : phase U white : phase V red : phase W yellow/green : ground ACCESSORIES...A...2...0.25.mil Yellow : No connection Orange : No connection Green : Brake Green Red : Brake</p> <p>if the option is required</p>

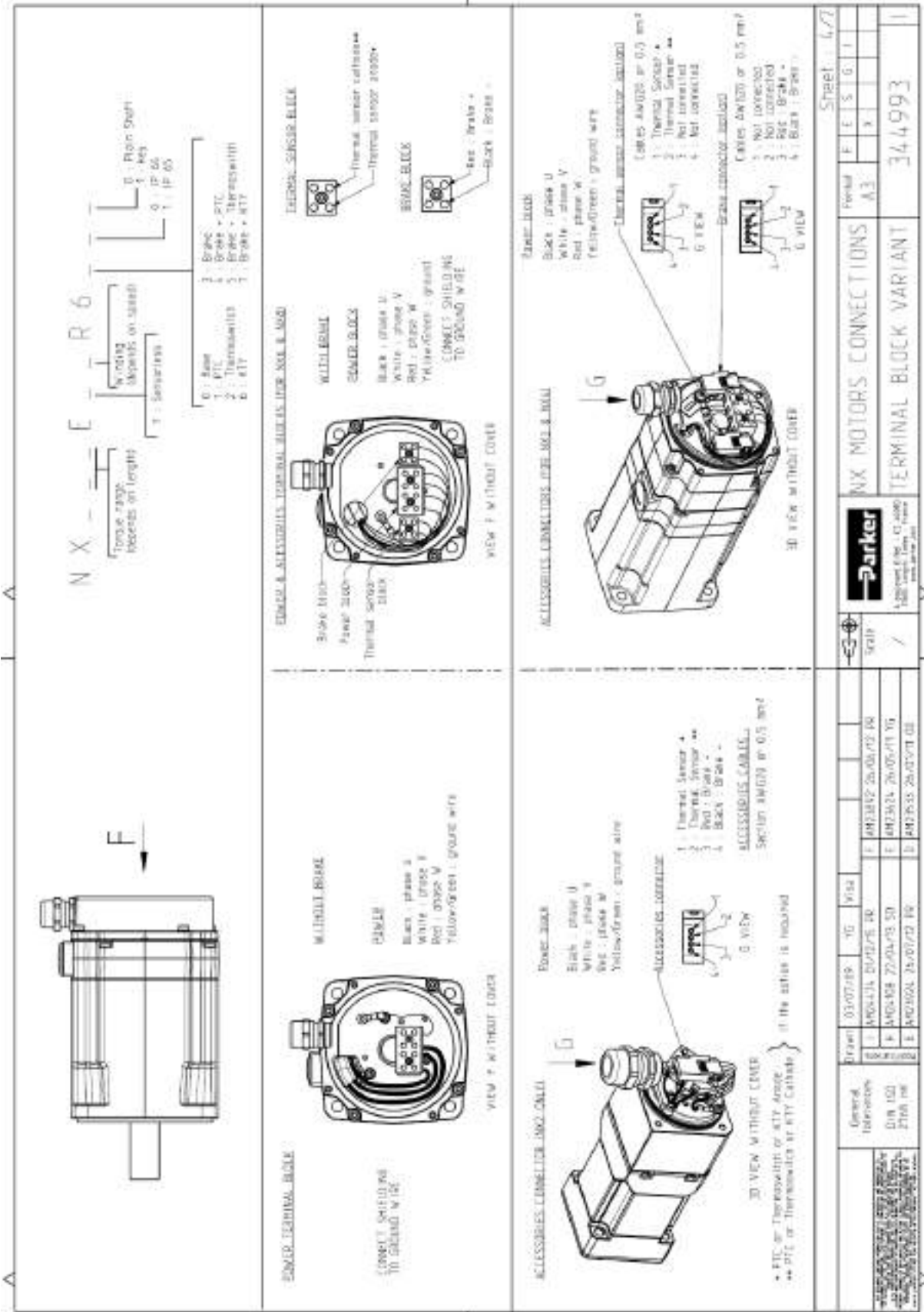

Sheet : 4/7	
NX MOTORS CONNECTIONS	
Formal	A.3
TERMINAL BLOCK VARIANT 344993	
<small>Address 6 rue - 47 4000 47 4000 - 47 4000 47 4000 - 47 4000</small>	
Drawn	03/07/19
YG	Y52
YG	Y52
F	AN23812 26/06/19 00
F	AN23824 26/06/19 00
F	AN23824 26/06/19 00
E	AN23824 26/06/19 00
E	AN23824 26/06/19 00
General Information	
DIN ISO	
PT68	

Power Connector
Signal Connector
No signal connector for feedback (for V, P, V)

30" (762 mm)

4.448 in (113 mm)

Cable gland - Ø5.5 to Ø14.5

N X - E - R 7

Temp sense (depends on length)

Temp sense (depends on speed)

0 - Brain Start
1 - 1P-2A
2 - 1P-2S

EXCEPT NX MOTORS and Exact MEXX2 motors for feedback letter P/Q

TEMPERATURE SENSORS

A : Resistor
B : Inertia Singulum DS1, S12, EAS36
C : Inertia Multifurn DS1, S12, EM34
D : Inertia Singulum SRS 35 - 028
E : Inertia Multifurn SSM 28 - 028
F : Inertia Multifurn SSM 28 - 028
G : Inertia Multifurn SSM 28 - 028
H : Inertia Multifurn SSM 28 - 028
I : Inertia Multifurn SSM 28 - 028
J : Inertia Multifurn SSM 28 - 028
K : Low Cost Inertia - 2014
L : Singulum

Temperature Sensor on Power Connector

0 : None
1 : PTC
2 : Thermowitch
A : RTV

Temperature Sensor on Signal Connector

A : PTC
B : Inertia
C : Thermowitch
E : Sing - PTC
F : Sing - Thermowitch
G : RTV

Not Applicable for feedback letter P, P/Q.

EXACT FEEDBACK LETTER P/Q

A : Brake
B : Drive
C : Temperature sensor
D : Temperature sensor

If the option is required

If the option is required

• PTC or Thermowitch or RTV Anode
• PTC or Thermowitch or RTV Cathode

SIGNAL CONNECTIONS

Feedback Letter : A
Feedback : 0 (none)

1 : S1
2 : S2
3 : Temperature sensor
4 : Temperature sensor
5 : S4
6 : S5
7 : S6
8 : S7
9 : S8
10 : S9
11 : S10
12 : S11

Feedback Letter : X
Feedback : 0 (none)

1 : Vc
2 : Temperature sensor
3 : Ground
4 : U
5 : V
6 : V
7 : Temperature sensor
8 : M
9 : M

ORDER SETTINGS

Feedback Letter : A
Motor powered by direct current at the current nominal value (M = at V-), (M = at V+), the shift is 90° electrical.

Feedback Letter : X
Motor powered by direct current at the current nominal value (M = at V-), (M = at V+), the shift is 90° electrical.

Feedback Letter : P/Q
Standard encoder settings. Motor powered by direct current at the current nominal value (M = at V-), (M = at V+), the shift is 90° electrical.

Order	03/07/85	Y6	Visa							
Order	03/07/85	Y6	Visa							
Order	03/07/85	Y6	Visa							
Order	03/07/85	Y6	Visa							
Order	03/07/85	Y6	Visa							
Order	03/07/85	Y6	Visa							

Sheet : 5/7

NX 1

Feedback depends on length
A - Encoder

Feedback depends on speed
R - 7

Temperature Sensor in Power Connector
E - Base
1 - Brake

NX 1

Feedback depends on length
A - Encoder

Feedback depends on speed
R - 7

Temperature Sensor in Power Connector
E - Base
1 - Brake

POWER CONNECTOR

A - Drive E
B - Drive V
C - Drive W
Feedback
1 - Brake
2 - Brake

} If the slider is required

SIGNAL CONNECTOR

Feedback Letter : A
Stroke(s) : 2 pins

1 - S1
2 - S2
3 - S3
4 - S4
5 - S5
6 - S6
7 - S7
8 - S8
9 - S9
10 - S10
11 - S11
12 - S12

S1 - On - S2 - Stop - S3 - activation - S4 - Stop - S5 - Stop - S6 - Stop - S7 - activation - S8 - Stop - S9 - Stop - S10 - Stop - S11 - Stop - S12 - Stop

ENCODER SETTINGS

Feedback Letter : A

Motor direction is direct current at the current reversal value (4V and 5V), the gain is 90° electrical.

Stroke	01/07/09	Y6	Y50
E	4824434	01/02/05	PR
F	4824882	26/06/12	PR
H	4824300	22/05/13	SB
G	4823924	26/07/12	PR
D	4823533	26/07/11	QE

General tolerances
D10 ISO
2708 mK

Sheet 6/7

F	I	S	G	I
A3	K			

NX MOTORS CONNECTIONS

CONNECTOR VARIANT

344993



3.9. Feedback system

3.9.1. Resolver 2 poles transformation ratio = 0.5 – code A

	NX1	NX2 & NX3	NX4, NX6 & NX8
Parker part number	220005P1000	220005P1001	220005P1002
Electrical specification	Values @ 8 kHz		
Polarity	2 poles		
Input voltage	7 Vrms		
Input current	70mA maximum	86mA maximum	
Zero voltage	20mV maximum		
Encoder accuracy	± 10' maxi		
Ratio	0,5 ± 5 %		
Output impedance (primary in short circuit whatever the position of the rotor)	Typical 120 + 200j Ω		
Dielectric rigidity (50 – 60 Hz)	500 V – 1 min		
Insulation resistance	≥ 10MΩ	≥ 100MΩ	
Rotor inertia	~6 g.cm ²	~30 g.cm ²	
Operating temperature range	-55 to +155 °C		

3.9.2. Hiperface encoder singleturn EKS36 DSL SIL2 – code P

	NX1	NX2, NX3, NX4, NX6 & NX8
Model	N/A	EKS36 SIL2 (Sick)
Type		Absolute single turn encoder
Parker part number		220174P0011
Electrical interface		Hiperface DSL
Position values per revolution		4096
Integral non-linearity		± 80''
Differential non-linearity		± 40''
Perating speed		12 000 rpm
Power Supply		7VDC to 12VDC
Current consumption		Max 150mA
Output frequency		0kHz – 75kHz
Operating temperature range		-20°C to +115 °C



3.9.3. Hiperface encoder multiturn EKM36 DSL SIL2 – code Q

	NX1	NX2, NX3, NX4, NX6 & NX8
Model	N/A	EKM36 SIL2 (Sick)
Type		Absolute multi turn encoder
Parker part number		220174P0012
Electrical interface		Hiperface DSL
Revolutions		4 096
Integral non-linearity		± 80"
Differential non-linearity		± 40"
Perating speed		9000 rpm
Power Supply		7VDC to 12VDC
Current consumption		Max 150mA
Output frequency		0kHz – 75kHz
Operating temperature range		-20°C to +115 °C

3.9.4. Hiperface encoder singleturn SKS36 (128pulses) – code R

	NX1	NX2, NX3, NX4, NX6 & NX8
Model	N/A	SKS36 (Sick)
Type		Absolute single turn encoder
Parker part number		220174P0003
Line count		128 sine/cosine periods per revolution
Electrical interface		Hiperface
Position values per revolution		4096
Error limits for the digital absolute value		± 320" (via RS485)
Integral non-linearity		± 80" (Error limits for evaluating sine/cosine period)
Differential non-linearity		± 40" (Non-linearity within a sine/cosine period)
Perating speed		12 000 rpm
Power Supply		7VDC to 12VDC
Current consumption (without load)		60mA
Output frequency		0kHz – 65kHz
Operating temperature range	-20°C to +110 °C	



3.9.5. Hiperface encoder multiturn SKM36 (128pulses) – code S

	NX1	NX2, NX3, NX4, NX6 & NX8
Model	N/A	SKM36 (Sick)
Type		Absolute multi turn encoder
Parker part number		220174P0004
Line count		128 sine/cosine periods per revolution
Electrical interface		Hiperface
Position values per revolution		4 096
Revolutions		4 096
Error limits for the digital absolute value		$\pm 320''$ (via RS485)
Integral non-linearity		$\pm 80''$ (Error limits for evaluating sine/cosine period)
Differential non-linearity		$\pm 40''$ (Non-linearity within a sine/cosine period)
Perating speed		9000 rpm
Power Supply Current consumption (without load)		7VDC to 12VDC 60mA
Output frequency		0kHz – 65kHz
Operating temperature range		-20°C to +110 °C

3.9.6. Hiperface encoder singleturn SRS50 (1024pulses) – code T

	NX1 & NX2	NX3, NX4, NX6 & NX8
Model	N/A	SRS50 (Sick)
Type		Absolute single turn encoder
Parker part number		220174P0002
Line count		1024 sine/cosine periods per revolution
Electrical interface		Hiperface
Position values per revolution		32 768
Integral non-linearity		$\pm 45''$ (Error limits for evaluating sine/cosine period)
Differential non-linearity		$\pm 7''$ (Non-linearity within a sine/cosine period)
Perating speed		6 000 rpm
Power Supply Current consumption (without load)		7VDC to 12VDC 80mA
Output frequency		0kHz – 200kHz
Operating temperature range		-30°C to +115 °C



3.9.7. Hiperface encoder multiturn SRM50 (1024pulses) – code U

	NX1 & NX2	NX3, NX4, NX6 & NX8
Model	N/A	SRM50 (Sick)
Type		Absolute multi turn encoder
Parker part number		220174P0001
Line count		1024 sine/cosine periods per revolution
Electrical interface		Hiperface
Position values per revolution		32 768
Revolutions		4 096
Integral non-linearity		$\pm 45''$ (Error limits for evaluating sine/cosine period)
Differential non-linearity		$\pm 7''$ (Non-linearity within a sine/cosine period)
Perating speed		6 000 rpm
Power Supply Current consumption (without load)		7VDC to 12VDC 80mA
Output frequency		0kHz – 200kHz
Operating temperature range		-30°C to +115 °C

3.9.8. Endat encoder singleturn ECN1113 – code V

	NX1 & NX2	NX3, NX4, NX6 & NX8
Model	N/A	ECN 1113 (Heidenhain)
Type		Absolute single turn encoder
Parker part number		220165P0002
Line count		512 sine/cosine periods per revolution
Electrical interface		Endat2.2
Position values per revolution		8 192 (13 bits)
System accuracy		$\pm 60''$
Perating speed		12 000 rpm
Power Supply Current consumption (without load)		3.6VDC to 14VDC 85mA @ 5VDC
Cutoff frequency – 3 dB		≥ 190 kHz typical
Operating temperature range		-40°C to +115 °C

3.9.9. Endat encoder multiturn ECN1125 – code W

	NX1 & NX2	NX3, NX4, NX6 & NX8
Model	N/A	ECN 1125 (Heidenhain)
Type		Absolute multi turn encoder
Parker part number		220165P0001
Line count		512 sine/cosine periods per revolution
Electrical interface		Endat2.2
Position values per revolution		8 192 (13 bits)
Revolutions		4 096
System accuracy		± 60"
Perating speed		12 000 rpm
Power Supply Current consumption (without load)		3.6VDC to 14VDC 105mA @ 5VDC
Cutoff frequency – 3 dB		≥ 190kHz typical
Operating temperature range		-40°C to +115 °C

	<p>With unregulated power supply (AC890 PARKER drive for instance), the max cable length is 65m with 0.25mm² power supply wire due to the voltage drop into the cable itself.</p>
---	---



Maximum Endat cable length

Please refer to the following curve to calculate the max cable length depending on the clock frequency

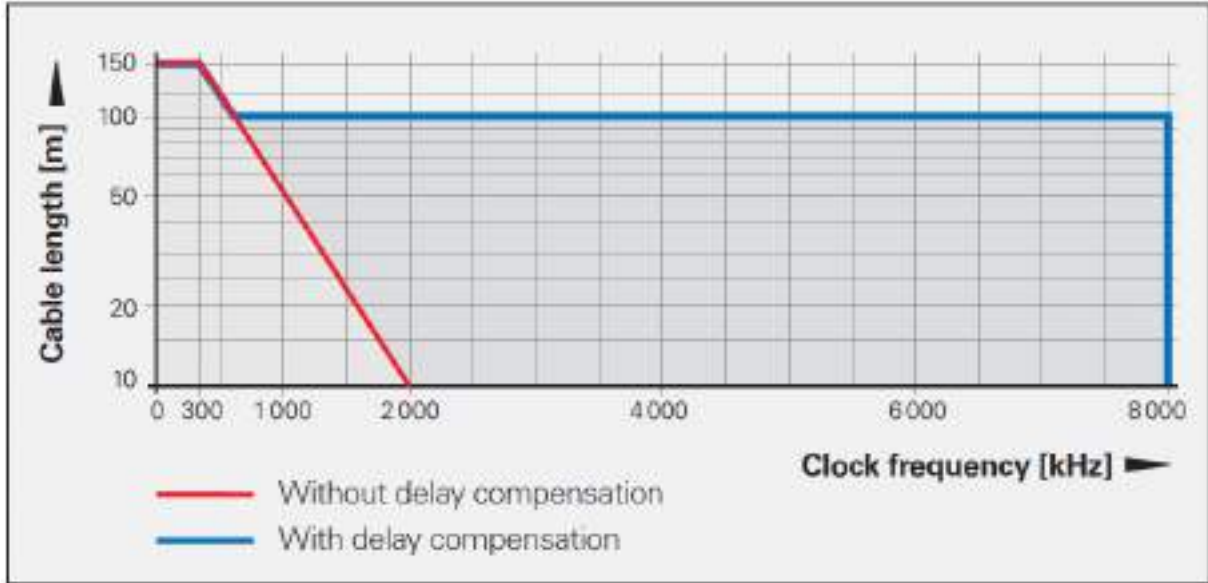

AC890 PARKER Wiring – EnDat encoder

From Heidenhain

Data (measured values or parameters) can be transferred bidirectionally between position encoders and subsequent electronics with transceiver components in accordance with RS-485 (differential signals), in synchronism with the clock signal produced by the subsequent electronics.

Dimensioning

IC₁ = RS-485 differential line receiver and driver

C₃ = 330 pF

Z₀ = 120 Ω

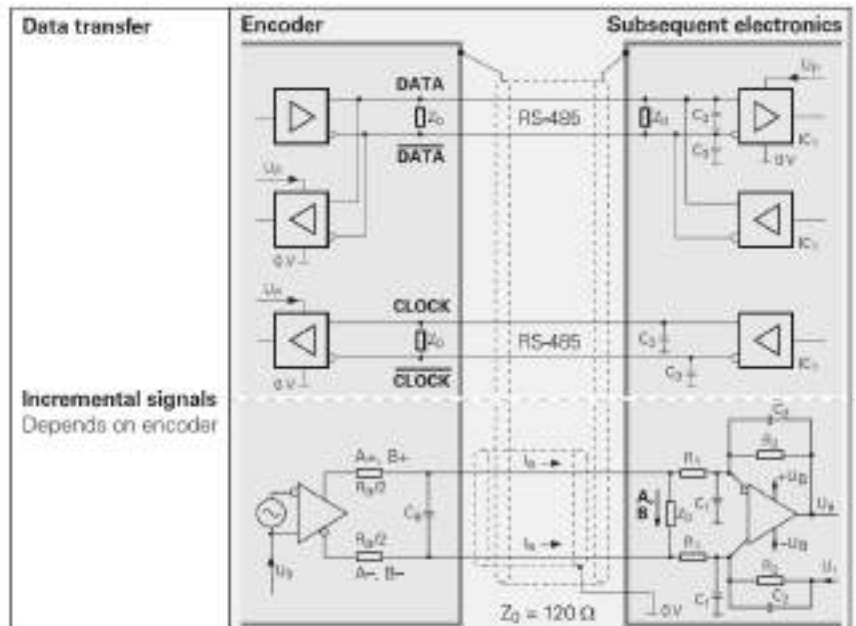



**3.9.10. Incremental encoder-Commutated lines 10 poles-2048pulses-
code X (On request)**

	NX1, NX2, NX3, NX4, NX6 & NX8
Model	F10 (Hengstler)
Type	Incremental encoder with 10 pole commutation signals
Parker part number	220167P0003
Line count	2048 pulses per revolution
Electrical interface	Line driver 26LS31
System accuracy	Incremental signals $\pm 2.5'$ commutation signals $\pm 6'$
Perating speed	5 000 rpm
Power Supply Current consumption (without load)	5VDC $\pm 10\%$ 100mA
Max pulse frequency	300 kHz
Operating temperature range	0°C to +120 °C



3.9.11. Cables

To connect NX motor in connector version to PARKER drive : AC890, COMPAX3 or SLVD, you can use complete cable with part number on the tabs below.

The "xxx" in the part number must be replaced by the length in meter.

Ex : for 20m cable, "xxx" = 020.

3.9.11.1. Signal cable

Feedback Sensor	Cable reference for AC890	Cable reference for COMPAX3	Cable reference for SLVD	Cable reference for 637/638
Resolver for NX1	CS4UA1F4R0xxx	CC3UA1F4R0xxx	CS5UA1F4R0xxx	CS2UA1F4R0xxx
Resolver for NX2 to NX8	CS4UA1F1R0xxx	CC3UA1F1R0xxx	CS5UA1F1R0xxx	CS1UA1F1R0xxx
Hiperface encoder	N/A	CC3UR1F1R0xxx	CS5UR1F1R0xxx	CS2UR1F1R0xxx
EnDat Encoder	CS4UV1F3R0xxx	CC3UV1F3R0xxx	CS5UV1F3R0xxx	N/A

For other drive, you can assembly cable and plug by soldering with part number on the tab below:

Feedback Sensor	Cable reference	Plug reference
Resolver for NX1	6537P0047	220132R6620
Resolver for NX2 to NX8	6537P0047	220065R4621
Hiperface Encoder	6537P0048	220065R4621
EnDat Encoder	6537P0055	220132R4641



3.9.11.2. Power cable with or without brake

Motor size	Cable reference for AC890	Cable reference for COMPAX3	Cable reference for SLVD	Cable reference for 637/638
NX1	CS4UP0F4R0xxx	CC3UP0F4R0xxx	CS5UP0F4R0xxx	CS2UP0F4R0xxx
for NX2 to NX8 Current ≤ 12Amps	CS4UP1F1R0xxx	CC3UP1F1R0xxx	CS5UP1F1R0xxx	CS2UP1F1R0xxx
for NX2 to NX8 Current ≤ 24Amps	CS4UP2F1R0xxx	CC3UP2F1R0xxx	CS5UP2F1R0xxx	CS2UP2F1R0xxx

For other drive, you can assembly cable and plug by soldering with part number on the tab below:

Motor size	Cable reference	Plug reference
NX1	6537P0054	220132R6610
for NX2 to NX8 Current ≤ 12Amps	6537P0049	220065R1610
for NX2 to NX8 Current ≤ 24Amps	6537P0050	220065R1610

3.9.11.3. Power cable with or without brake and thermal sensor

Motor size	Cable reference for AC890	Cable reference for COMPAX3	Cable reference for SLVD	Cable reference for 637/638
Current ≤ 12Amps	CS4UQ1F1R0xxx	CC3UQ1F1R0xxx	CS5UQ1F1R0xxx	CS2UQ1F1R0xxx
Current ≤ 24Amps	CS4UQ2F1R0xxx	CC3UQ2F1R0xxx	CS5UQ2F1R0xxx	CS2UQ2F1R0xxx

For other drive, you can assembly cable and plug by soldering with part number on the tab below:

Motor size	Cable reference	Plug reference
Current ≤ 12Amps	6537P0043	220065R1610
Current ≤ 24Amps	6537P0046	220065R1610



3.9.11.4. Power cable with or without brake and Hiperface DSL encoder

Motor size	Cable reference for PSD / SLVD
Current \leq 12Amps	CP1UD1F1R0xxx
Current \leq 24Amps	CP1UD2F1R0xxx

For other drive, you can assembly cable and plug by soldering with part number on the tab below:

Feedback Sensor	Cable reference	Plug reference
Current \leq 12Amps	Consult us	220065R1610
Current \leq 24Amps	Consult us	220065R1610

3.10. Brake option



Caution: The holding brake is used to completely immobilize the servomotor under load. It is not designed to be used for repeated dynamic braking ; dynamic braking must only be used in the case of an emergency stop and with a limited occurrence depending on the load inertia and speed.

The standard brake power supply is 24 V_{cc} DC ± 10%.

Follow the polarity and the permissible voltage, and use shielded cables.

A 220 µF capacitor avoids untimely braking if the 24 V voltage is disturbed by the external relay. Check the voltage value once this capacitor has been fitted. The RC network (220 Ω, 0.1 µF) is needed to eliminate interference produced by the brake coil.

Position the contactor in the DC circuit to reduce brake response times. Follow the connection instructions taking the brake polarisation into account.

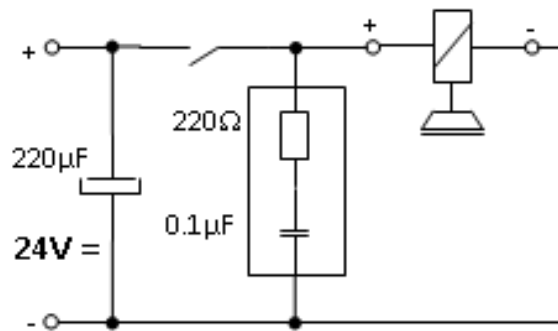

Motor	Static torque @20°C (N.m)	Static torque @100°C (N.m)	Power (W)	Engaging time (braking) (ms)	Disengaging time (Unbraking) (ms)	Extra Inertia (Kg.m ² .10 ⁻⁵)	Angular backlash (°)
NX1	0.4		6	27	13	0.1	0
NX2	1		8	14	28	1.2	0
NX3	2	1.8	11	13	25	0.68	0
NX4	5.5	4	12	17	35	1.8	0
NX6	12	8	18	28	40	5.4	0
NX8	36	32	26	45	100	55.6	0

Table with typical values

4. COMMISSIONING, USE AND MAINTENANCE

4.1. Instructions for commissioning, use and maintenance

4.1.1. Equipment delivery

All servomotors are strictly controlled during manufacturing, before shipping. While receiving it, it is necessary to verify motor condition and if it has not been damaged in transit. Remove it carefully from its packaging. Verify that the data written on the label are the same as the ones on the acknowledgement of order, and that all documents or needed accessories for user are present in the packaging.



Warning: In case of damaged material during the transport, the recipient must **immediately** make reservations to the carrier through a registered mail within 24 h..

4.1.2. Handling

Servomotors are equipped with two lifting rings intended for handling.



Caution: Use only servomotors lifting rings, if present, or slings to handle the motor. Do not handle the motor with the help of electrical cables, connectors and water inputs/outputs, or use any other inappropriate method.

The drawings below show the correct handling procedure.

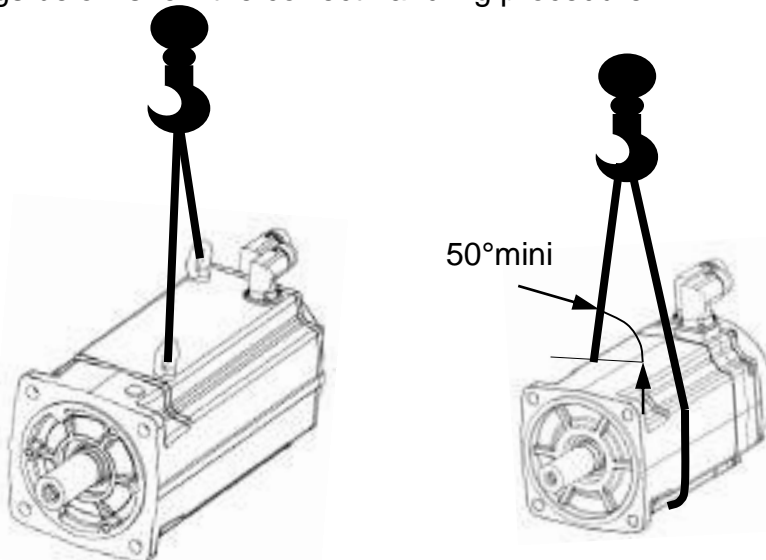

DANGER: Choose the correct slings for the motor weight. The two slings must be the same length and a minimum angle of 50° has to be respected between the motor axis and the slings.

4.1.3. Storage

Before being mounted, the motor has to be stored in a dry place, without rapid or important temperature variations in order to avoid condensation.

During storage, the ambient temperature must be kept between -20 and +60°C.

If the torque motor has to be stored for a long time, verify that the shaft end, feet and the flange are coated with corrosion proof product.

After a long storage duration (more than 3 month), run the motor at low speed in both directions, in order to blend the bearing grease spreading.

The motor is delivered with caps for the water inlet and outlet to protect the cooling circuit. Keep them on place until the motor commissioning.

4.2. Installation

4.2.1. Mounting

Foundation must be even, sufficiently rigid and shall be dimensioned in order to avoid vibrations due to resonance. Before bolting the motor, the foundation surface must be cleaned and checked in order to detect any excessive height difference between the motor locations. The surface variation shall not exceed 0,1 mm.

	<p><u>Caution:</u> The user bears the entire responsibility for the preparation of the foundation.</p>
--	--

The table below gives the average tightening torques required regarding the fixing screw diameter. These values are valid for both motor's feet and flange bolting.

Screw diameter	Tightening torque
M2 x 0.35	0.35 N.m
M2.5 x 0.4	0.6 N.m
M3 x 0.5	1.1 N.m
M3.5 x 0.6	1.7 N.m
M4 x 0.7	2.5 N.m
M5 x 0.8	5 N.m
M6 x1	8.5 N.m
M7 x 1	14 N.m
M8 x 1.25	20 N.m

Screw diameter	Tightening torque
M9 x 1.25	31 N.m
M10 x 1.5	40 N.m
M11 x 1.5	56 N.m
M12 x 1.75	70 N.m
M14 x 2	111 N.m
M16 x 2	167 N.m
M18 x 2.5	228 N.m
M20 x 2.5	329 N.m
M22 x 2.5	437 N.m
M24 x 3	564 N.m



	<p><u>Warning:</u> After 15 days, check all tightening torques on all screw and nuts.</p>
---	---

4.2.2. Preparation

Once the motor is installed, it must be possible to access the wiring, and read the manufacturer's plate. Air must be able to circulate around the motor for cooling purposes.

Clean the shaft using a cloth soaked in white spirit or alcohol. Pay attention that the cleaning solution does not get on to the bearings.

The motor must be in a horizontal position during cleaning or running.

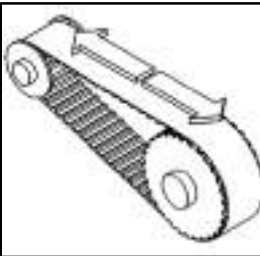
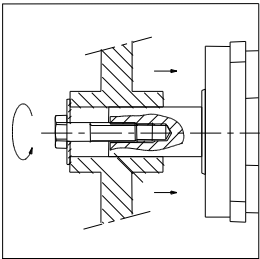
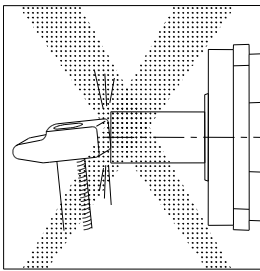

	<p><u>Caution:</u> Do not step on the motor, the connector or the terminal box</p>
	<p><u>Caution:</u> Always bear in mind that some parts of the surface of the motor can reach temperatures exceeding 100°C</p>

4.2.3. Mechanical installation







The operation life of servomotor bearings depends largely on the care and attention given to this operation.

- In the event that the servomotor shaft has a cotter pin, make sure that the coupling components have been balanced correctly without the cotter pin, the servomotor having been balanced with its cotter pin.
- Prohibit any impact on the shaft and avoid press fittings which could mark the bearing tracks. If press fitting cannot be avoided, it is advisable to immobilize the shaft in motion; this solution is nevertheless dangerous as it puts the resolver at risk.
- Use the thread at the end of the shaft in accordance with the diagram for fitting pulleys or accessories. It is possible to put pressure on the shoulder of the shaft located in front of the bearing.
- In the event that the front bearing block is sealed by a lip seal which rubs on the rotating section (version IP 65), we recommended that you lubricate the seal with grease thus prolonging its operational life.
- In the event that the drive system uses a pulley and belt, the drive pulley must be fixed as close as possible to the flange. The pulley diameter is to be selected so that the radial load does not exceed the limits given in the catalog.

	<p>Warning : a misalignment of the coupling device makes stress and load on the motor shaft depending the rigidity of the installation. The variations of the temperature makes stress and load due to the dilatation. These loads (axials and radiale) do not exceed the load written (§ 3.5).</p>
	<p><u>Warning</u> : The misalignment of the coupling device makes vibration who can realize a destruction of the motor shaft.</p>
	<p>We cannot be held responsible for wear on the drive shaft resulting from excessive strain.</p>

4.3. Electrical connections



	<p><u>Danger</u>: Check that the power to the electrical cabinet is off prior to making any connections.</p>
	<p><u>Caution</u>: The wiring must comply with the drive commissioning manual and with recommended cables.</p>
	<p><u>Danger</u>: The motor must be earthed by connecting to an unpainted section of the motor.</p>
	<p><u>Caution</u>: After 15 days, check all tightening torques on cable connection.</p>

4.3.1. Cable connection

Please, read §3.7 "Electrical connection" to have information about cable connection

Many useful information are already available in the drive documentations.

4.3.2. Encoder cable handling

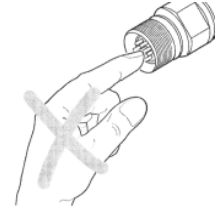
	<p><u>Danger:</u> before any intervention the drive must be stopped in accordance with the procedure.</p>
	<p><u>Caution:</u> It is forbidden to disconnect the Encoder cable under voltage (high risk of damage and sensor destruction).</p>
	<p><u>Warning:</u> Always wear an antistatic wrist strap during encoder handling.</p>
	<p><u>Warning:</u> Do not touch encoder contacts (risk of damage due to electrostatic discharges ESD).</p>

4.4. Maintenance Operations

4.4.1. Summary maintenance operations

	<p>Generality <u>DANGER:</u> The installation, commission and maintenance operations must be performed by qualified personnel, in conjunction with this documentation.</p> <p>The qualified personnel must know the safety (C18510 authorization, standard VDE 0105 or IEC 0364) and local regulations.</p> <p>They must be authorized to install, commission and operate in accordance with established practices and standards.</p> <p>Please contact PARKER for technical assistance.</p>
---	--

	<p><u>Danger:</u> before any intervention the motor must be disconnected from te power supply. Due to the permanent magnets, a voltage is generated at the terminals when the motor shaft is turned</p>
--	--

Operation	Periodicity
Clean the motor	Every year
Motor inspection (vibration changes, temperature changes, tightening torques on all screws)	Every year
Bearing replacement	Every 20 000h
No water condensation checking for water cooling version	Every year
Cooling water quality inspection for water cooling version	Every year

4.5. Troubleshooting

Some symptoms and their possible causes are listed below. This list is not comprehensive. Whenever an operating incident occurs, consult the relevant servo drive installation instructions (the troubleshooting display indications will help you in your investigation) or contact us at: <http://www.parker.com/eme/repairservice>.

<p>You note that the motor does not turn by hand when the motor is not connected to the drive.</p>	<ul style="list-style-type: none"> • Check there is no mechanical blockage or if the motor terminals are not short-circuited. • Check the power supply to the brake.
<p>You have difficulty starting the motor or making it run</p>	<ul style="list-style-type: none"> • Check on the fuses, the voltage at the terminals (there could be an overload or the bearings could be jammed), also checks on the load current. • Check the power supply to the brake (+ 24 V \pm 10 %) and its polarity. • Check on any thermal protection, its connection and how it is set in the drive. • Check on the servomotor insulation (if in doubt, carry out hot and cold measurements). <p>The minimum insulation resistance value measured under a max. 50V DC is 50 MΩ:</p> <ul style="list-style-type: none"> • Between the phase and the casing • Between the thermal protection and the casing • Between the brake coil and the casing • Between the resolver coils and the casing.
<p>You find that the motor speed is drifting</p>	<ul style="list-style-type: none"> • Reset the offset of the servoamplifier after having given a zero instruction to the speed setpoint input.
<p>You notice that the motor is racing</p>	<ul style="list-style-type: none"> • Check the speed setpoint of the servo drive. • Check you are well and truly in speed regulation (and not in torque regulation). • Check the encoder setting • Check on the servomotor phase order: U, V, W
<p>You notice vibrations</p>	<ul style="list-style-type: none"> • Check the encoder and tachometer connections, the earth connections (carefully) and the earthing of the earth wire, the setting of the servo drive speed loop, tachometer screening and filtering. • Check the stability of the secondary voltages. • Check the rigidity of the frame and motor support..

<p>You think the motor is becoming unusually hot</p>	<ul style="list-style-type: none"> • It may be overloaded or the rotation speed is too low : check the current and the operating cycle of the motor. • Check if the mounting surface is enough or if this surface is not a heat source – see §3.6 cooling. • Friction in the machine may be too high : <ul style="list-style-type: none"> • Test the motor current with and without a load. • Check the motor does not have thermal insulation. • Check that there is no friction from the brake when the brake power is on. • Check the cooling circuit
<p>You find that the motor is too noisy</p>	<p>Several possible explanations :</p> <ul style="list-style-type: none"> • Unsatisfactory mechanical balancing • There is friction from the brake: mechanical jamming. • Defective coupling • Loosening of several pieces • Poor adjustment of servo drive or position loop : check rotation in open loop
<p>The motor is warmer on its top</p>	<p>Air bubbles can be stocked in the water cooling circuit. You need to purge the circuit or to double the water flow rate during 10 minutes to remove the air bubbles.</p>